

बीएआरसी
न्यूज़लेटर

BARC
NEWSLETTER

ISSUE NO. 308 | SEPTEMBER 2009



Homi Bhabha Birth Centenary Year
30 October 2008-30 October 2009



IN THIS ISSUE

DEVELOPMENT OF α - $\text{Al}_2\text{O}_3:\text{C}$ PHOSPHOR FOR PERSONNEL DOSIMETRY USING OPTICALLY STIMULATED LUMINESCENCE TECHNIQUE



Sketch by Dr. Homi J. Bhabha

CONTENTS

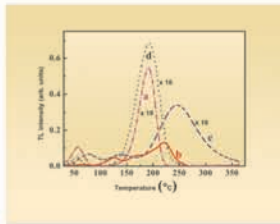

Development of α -Al₂O₃:C phosphor for Personnel Dosimetry using Optically Stimulated Luminescence technique 2



PLC-Based Pneumatic Control System for Cesium Food Irradiator 9



Statement by Dr. Anil Kakodkar, Chairman Atomic Energy Commission & Leader of the Indian Delegation at the 53rd General Conference, of the IAEA, Vienna, 16th September 2009 12

भा.प.अ. केंद्र के वैज्ञानिकों को सम्मान
BARC Scientists Honoured 17

URL:<http://www.barc.gov.in>



DR. HOMI BHABHA CENTENARY YEAR

DEVELOPMENT OF $\alpha\text{-Al}_2\text{O}_3\text{:C}$ PHOSPHOR FOR PERSONNEL DOSIMETRY USING OPTICALLY STIMULATED LUMINESCENCE TECHNIQUE

K.P. Muthe, S.K. Gupta, J.V. Yakhmi

Technical Physics and Prototype Engineering Division

and

M.S. Kulkarni, D.R. Mishra, N.S. Rawat and D.N. Sharma

Radiation Safety Systems Division

Introduction

Thermoluminescence (TL) and Optically Stimulated Luminescence (OSL) dosimetry, play an important role in the measurement of doses from external radiation source, received by individuals working in radiation environment such as nuclear reactors, industrial radiography, space and diagnostic radiology applications. Conventionally, radiation monitoring has been carried out using Thermally Stimulated Luminescence (TSL) technique. In this technique, ionizing radiation creates electrons and holes, some of which are trapped in metastable energy levels (called trapping centres) created by pre-existing defects in the material. For measurement of radiation, the material is heated, whereby trapped carriers are excited to conduction band (for electrons) or valence band (for holes), where they are mobile. As the carriers move, they are captured by other types of energy levels created by defects (called luminescence centres). This results in emission of light, which is measured by using a photomultiplier tube. The integrated intensity of emitted light is a measure of radiation received by the material (i.e. absorbed dose). In a relatively recent technique called Optically Stimulated Luminescence (OSL), carriers are excited from trapping centres, using visible light for stimulation instead of heat. Generally, the stimulation is carried out by light of wavelength outside the emission spectrum, (selected using dependence of photo-ionization cross-section of the

trap energy levels on wavelength) in order to separate the emitted light from that used for excitation. Alternatively, short pulses (< 500 ns) are used for excitation and emitted light is monitored in between excitation pulses. OSL mode of luminescence has added advantage of operation at room temperature and helps avoid thermal quenching [1] which leads to partial loss of luminescence signal at high temperatures (> 100 °C). In addition to this, OSL mode enables faster as well as multiple readouts of doses and can be employed for remote measurements too. This has been demonstrated in the case of rare earth doped Alkaline Earth Sulphides (AES) like SrS and CaS [2]. However, AES phosphors have some limitations, such as : a large difference in effective atomic number (Z_{eff}) as compared to human tissue (7.4), significant loss of dose-related information with time due to fading at room temperature and a limited interaction volume arising from their opaque nature. These limitations have been satisfactorily overcome with the advent of highly sensitive, transparent and chemically robust OSL phosphor, anion-deficient $\alpha\text{-Al}_2\text{O}_3\text{:C}$ [3] that is 40-60 times more sensitive than LiF:Mg,Ti (TLD100), has very low dose threshold ($\sim 10^{-6}$ Gy) and saturation at quite high doses of ~ 30 Gy. A wide functional range of about seven orders of magnitude together with high sensitivity, make this phosphor extremely versatile. It has found applications in low dose dosimetry for environmental monitoring as well as in personnel, medical and accident dosimetry [4].

Anion deficient alumina ($\alpha\text{-Al}_2\text{O}_3\text{:C}$) for OSL dosimetry is generally prepared, by subtractive colouration of alumina single crystals, in reducing environment of graphite, that results in substitution of Al^{3+} by C^{2+} . The term “subtractive colouration” is used because the colour centres result from the extraction of oxygen atoms, through the decomposition of Al_2O_3 at this very high temperature, rather than the introduction of aluminium atoms from a vapour phase, rich in aluminium atoms (additive coloration). Basically, the thermochemical process is the same for both colouration methods [5]. Due to this, oxygen vacancies are created, leading to F (two electrons in anion vacancy field) and F^+ (single electron in anion vacancy field) type defects. These defects act as recombination centres responsible for its high sensitivity. The emission spectrum of $\alpha\text{-Al}_2\text{O}_3\text{:C}$ consists of radiation at 420 and 330 nm. The emission at 420 nm has been explained to be due to the result of recombination of thermally or optically released electron with F^+ centre, leading to the formation of an excited F centre, which undergoes a radiative relaxation to ground state [5, 6]. Appearance of peak at 330 nm has been explained in terms of hole traps. The thermally released holes may recombine with F centres resulting in the formation of excited F^+ centres which emit at 330 nm or transfer energy to F centres yielding emission at 420 nm as well [7].

While recombination centres in Al_2O_3 have been fairly well identified to be F and F^+ centres, the nature of dosimetry traps has not been well studied. Positron lifetime measurements on crystals nominally prepared in reducing atmosphere, showed evidence of the presence of aluminium vacancies [8], and it has been suggested that aluminium vacancies act as trapping centres [9]. Positron Annihilation Spectroscopy can be used, to identify the nature of such Al vacancies, where positrons are trapped and therefore, we have used this technique to investigate Al vacancies that are likely to be dosimetry traps [10].

Conventional technique of making $\alpha\text{-Al}_2\text{O}_3\text{:C}$ phosphor, by growth of single crystals in reducing environment, has limitations of: (a) limited control of parameters for incorporation of desired concentration of carbon into lattice and control over nature of defects as crystal growth occurs at a fixed temperature and growth rate etc. and (b) slow growth process using expensive equipment, that increases cost of material. To overcome these limitations, we have developed two techniques at BARC. The first technique is based on annealing of alumina single crystals under vacuum in the presence of graphite [11]. By controlling annealing temperature, time and heating/cooling rate, materials with different characteristics can be prepared. For example, by varying the thermal treatment i.e. slow and fast cooling [12] of the samples, from annealing temperature of 1500°C , Main Dosimetry Peak (MDP) or a Low Temperature Peak (LTP) may be enhanced. In the second technique, alumina powder is melted in reducing environment and cooled to yield polycrystalline material [13], that may in principle, have similar sensitivity as single crystals, because single crystals are also ground into small crystallites to make dosimeters. To show the feasibility of this technique, alumina was melted in a graphite crucible using electron gun-based, thin film vacuum deposition system. Having shown the feasibility of the technique, a facility for melting larger quantities using induction heating system is being set up. Characteristics of materials developed at BARC and results of positron annihilation studies are discussed in the following sections.

Phosphor prepared by thermal annealing

By thermal annealing of commercial Al_2O_3 single crystals under reducing environment, two different types of materials were prepared: (a) conventional material with dosimetry peak at $\sim 190^\circ\text{C}$ [11] and (b) material with enhanced low temperature peak [12].



Conventional material

Material with dosimetry properties similar to the reported $\alpha\text{-Al}_2\text{O}_3\text{:C}$ was prepared by heating commercial alumina single crystals of $10 \times 10 \times 0.4 \text{ mm}^3$, in the presence of graphite at temperature of $\sim 1500^\circ\text{C}$ [11]. In this process, carbon is diffused into the crystals, leading to creation of F centres. The heating was carried out in vacuum furnace with base vacuum of 10^{-6} Torr for a period of 90 min, with uniform heating and cooling rates of $20^\circ\text{C}/\text{min}$. Typical optical absorption spectra of processed crystals (Fig. 1) showed F^+ centre peak at 203 nm and F^+ centre peaks at 225 and 255 nm, indicating suitability of the crystals for dosimetry.

The TL response of processed crystals is compared with some well known TL phosphors as well as commercially available $\alpha\text{-Al}_2\text{O}_3\text{:C}$ single crystals and shown in Fig. 2. For the TL studies, the samples were irradiated with $^{90}\text{Sr}/^{90}\text{Y}$ beta source to an adsorbed dose of 0.33 Gy and TL curves were measured at a constant heating rate of 4K/s. The

material prepared by us has two non-overlapping glow peaks, Low Temperature Peak (LTP) at $\sim 56^\circ\text{C}$ and Main Dosimetry Peak (MDP) at $\sim 190^\circ\text{C}$. The low temperature peak decays within a few minutes after

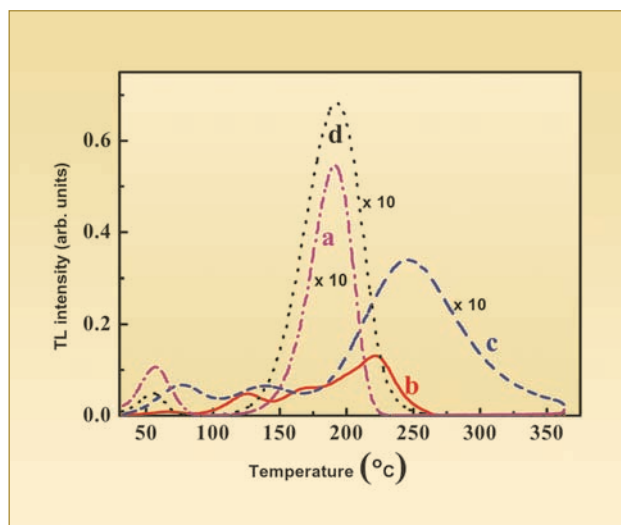

Fig. 2: Normalized TL intensity of (a) $\alpha\text{-Al}_2\text{O}_3\text{:C}$ prepared by thermal annealing at 1500°C for 90 mins, (b) LiF:Mg,Ti , (c) $\text{CaSO}_4\text{:Dy}$ and (d) $\alpha\text{-Al}_2\text{O}_3\text{:C}$ single crystals prepared in reducing environment. (The glow curves must be multiplied by factors shown with them and then compared).

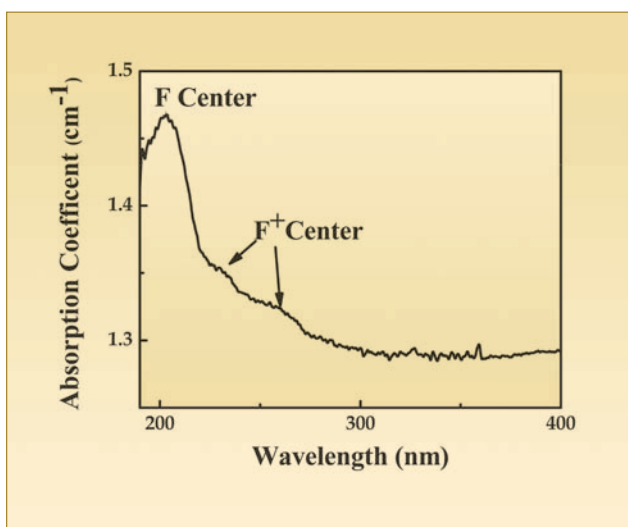

Fig. 1: Optical absorption spectra of single crystal $\alpha\text{-Al}_2\text{O}_3$ processed in vacuum at a temperature of 1500°C in the presence of graphite.

irradiation. The TL sensitivity of the prepared material is found to be 41 times that of TLD-100 and is quite comparable to $\alpha\text{-Al}_2\text{O}_3$ phosphor, prepared by conventional crystal growth technique.

OSL response of the material is compared with commercial alumina phosphor in Fig. 3. For these measurements, samples were irradiated to adsorbed dose of 12.5 mGy and optical excitation was carried out using blue light emitting diodes, with peak emission at 470 nm and irradiation of $100 \text{ mW}/\text{cm}^2$ at the sample position. Suitable filters were used to cut off light from excitation source, such that only luminescence from samples reached the photomultiplier tubes. The results of Fig. 3 show, that the processed crystals may be used for dosimetry in OSL mode. The samples were found

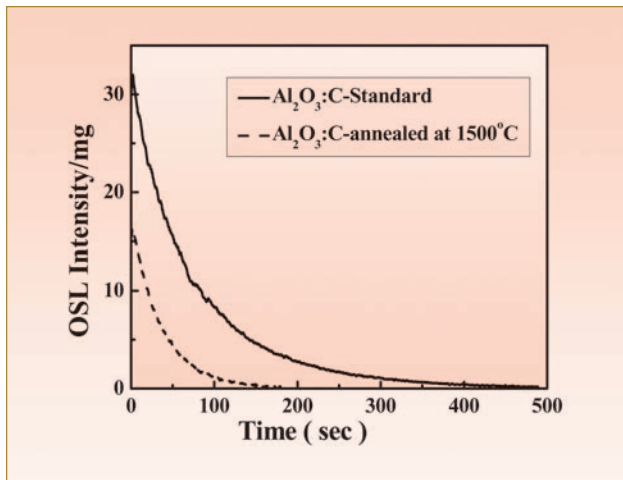

Fig. 3: OSL response of the processed and commercial $\text{Al}_2\text{O}_3:\text{C}$ samples for 12.5 mGy beta dose

to show linear response to beta dose, for irradiation upto more than 1 Gy, as shown in Fig. 4 and possess 2% sub-linearity in dose in the 1-6 Gy range. The samples could detect a minimum dose of 50 μGy using the BARC made OSL measurement set up [14].

$\alpha\text{-Al}_2\text{O}_3:\text{C}$ with intense low temperature TL peak

$\alpha\text{-Al}_2\text{O}_3:\text{C}$ material having enhanced Low Temperature Peak (LTP samples) was prepared in a manner similar

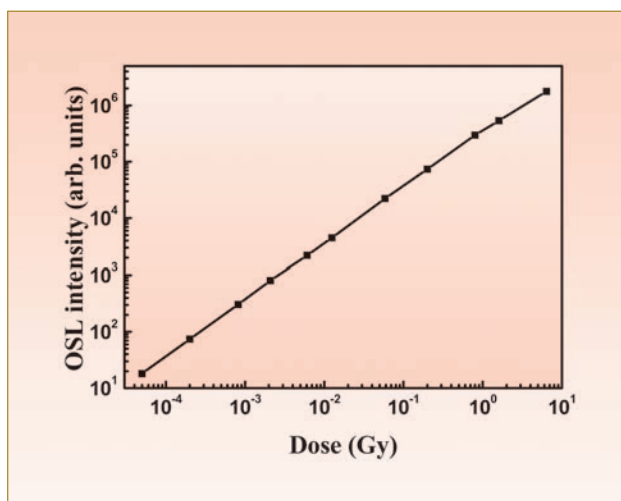

Fig. 4: Dose dependence of OSL response of the processed sample determined using beta radiation from $^{90}\text{Sr}/^{90}\text{Y}$ source.

to that described above except that, the samples were heated upto 1475°C and rapidly cooled by switching off the furnace immediately after the temperature was reached. This procedure resulted in samples with ~99% of the total integrated signal, contained in low temperature peak at ~ 64°C. The sensitivity of these samples was found to be nearly 200 times the TL sensitivity of glow peak 5 of TLD-100 with rapid fading in less than five minutes at room temperature. TL response of LTP samples is compared in Fig. 5 with that of commercially available conventional dosimetry material. Area

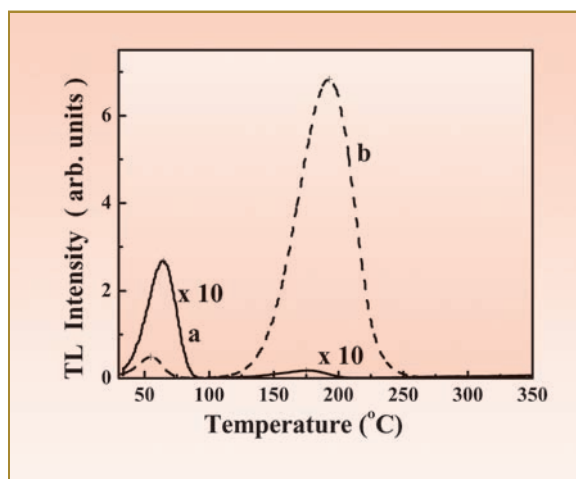

Fig. 5: TL Response of (a) sample with enhanced low temperature peak and (b) commercial Al_2O_3 single crystals.

ratio of LTP to MDP is found to be 9 for this material as compared to ~0.03 for conventional material showing quite significant enhancement of LTP. Thermal trap depth of the LTP material was found to be 1.07 eV by measurement of temperature dependence of phosphorescence lifetime. Integrated phosphorescence intensity of LTP samples (measured at room temperature 2 minutes after irradiation) was found to show linear dependence on dose (Fig. 6).

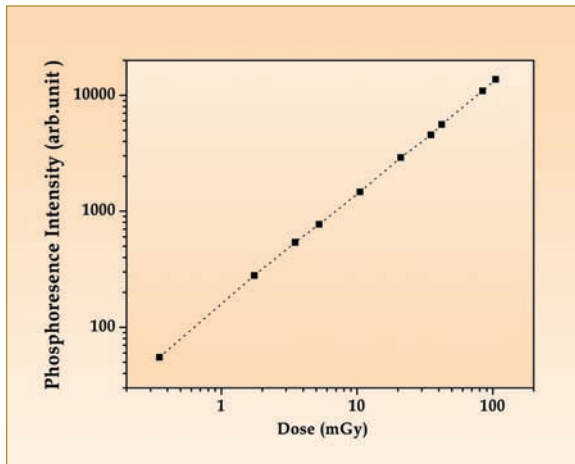

Fig. 6: Phosphorescence intensity of 64°C TL peak at room temperature as a function of dose in $\text{Al}_2\text{O}_3:\text{C}$ sample having intense low temperature peak.

Minimum detectable dose (3 σ limit) for room temperature phosphorescence was determined to be 65 μGy . OSL characteristics of this material are shown in Fig. 7, where CW-OSL response (with 470 nm light stimulation) of the sample read 2 and 30 minutes after exposure is shown along with phosphorescence decay signal without exposure to light. Comparison of the OSL signals (2 and 30 minutes) and phosphorescence

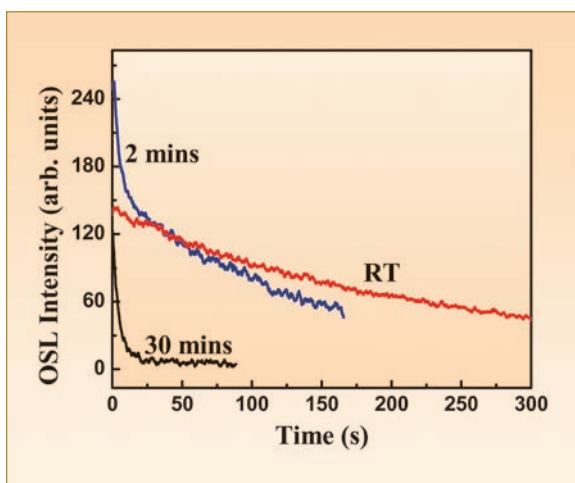

Fig. 7: The room temperature phosphorescence (RT) and the CW-OSL response of sample (quenched in presence of carbon at 1475°C), read 2 min. and 30 min. after irradiation.

decay signal show, that the OSL response after two minutes consists of two components (a) OSL response due to MDP and (b) phosphorescence decay of LTP. This shows that traps corresponding to LTP are not OSL sensitive, for 470 nm stimulation wavelength.

Material prepared by melting of polycrystalline alumina

To demonstrate the feasibility of the simple technique of melting polycrystalline alumina powder in graphite environment, to yield material suitable for dosimetry, alumina was melted using electron gun of a vacuum system, meant for the deposition of thin films. For this purpose, polycrystalline alumina powder was pressed into pellets of 10 mm dia and 2 mm thickness at a pressure of 50 kg/cm². The pellets were sintered at 1200°C to remove adsorbed gases that may degrade vacuum in the electron gun system. Melting was carried out in a copper crucible of 20 mm dia and ~ 12 mm height with a graphite liner, that provided the reducing environment needed for making the desired material. The pellets were slowly heated to melting temperature and maintained in molten state for 10 minutes and then slowly cooled. Typical TL glow curves of melt processed samples were compared with

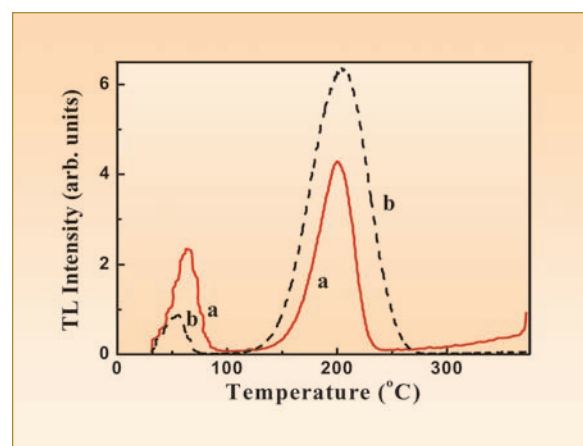

Fig. 8 : Comparison of the TL glow curves of (a) electron gun processed alumina and (b) commercially available single crystal $\alpha\text{-Al}_2\text{O}_3:\text{C}$.

commercial material prepared by crystal growth in reducing environment as shown in Fig. 8.

The intensity of MDP of melt processed samples was found to be ~ 65% of commercial material. As in an electron gun, melting parameters cannot be accurately controlled; use of this technique with an induction furnace for melting, is expected to yield better material as the processing parameters can be better optimized. The melt processed samples showed linear response over 3 μGy to 5 Gy range and minimum detectable

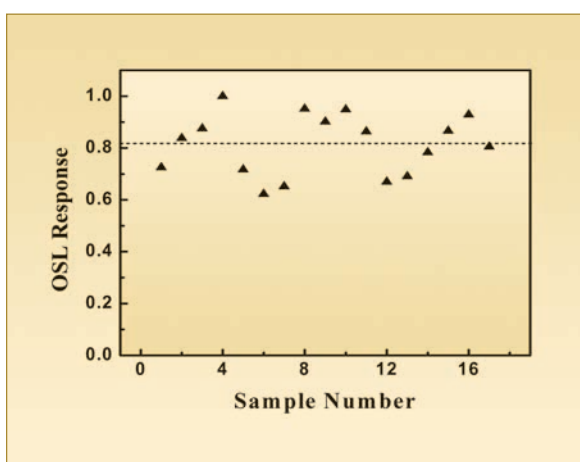

Fig. 9: Normalized OSL response for 17 electron gun processed samples to show sample-to-sample variation

dose was estimated to be 50 μGy . This shows the suitability of this simple technique, for yielding phosphor suitable for OSL dosimetry. The consistency of this process was checked by recording the variation in the OSL response among samples, processed under similar conditions. The variation in OSL response among the samples was found to be within $\pm 14\%$ as shown in Fig. 9.

Positron annihilation studies

Positron annihilation studies were carried out to understand the nature of dosimetry traps in $\alpha\text{-Al}_2\text{O}_3\text{:C}$.

It was found that carbon is associated with aluminium vacancies, acting as dosimetry traps in this material [10]. The study also showed that different types of aluminium vacancies are associated with traps responsible for LTP and MDP.

Conclusions

Two new techniques for preparation of $\alpha\text{-Al}_2\text{O}_3\text{:C}$ phosphor suitable for personnel dosimetry have been demonstrated. In the first method, $\alpha\text{-Al}_2\text{O}_3$ single crystals were heated in reducing environment in the presence of graphite. In comparison with conventional method of single crystal growth under reducing environment, this method has an advantage of creating tailored materials with desired characteristics. In the second method, a very simple and inexpensive technique of melt processing alumina powder in reducing environment was demonstrated, to yield material, suitable for dosimetry with characteristics comparable to conventional single crystal material.

References

1. M.S.Akselrod, N.A.Larsen, V.Whitley and S.W.S.McKeever. Thermal quenching of F-center luminescence in $\text{Al}_2\text{O}_3\text{:C}$. *J. Appl. Phys.* 84 (1998) 3364.
2. J. Gasiot, P. Braunlich and J.P., Fillard, Nanosecond infrared laser stimulation of luminescence in rare-earth doped sulphides. *Appl. Phys. Lett.*, 40 (1982) 376.
3. G.Ranchoux, S. Magne, J.P. Bouvet and P. Ferdinand, Fiber remote optoelectronic gamma dosimetry based on optically stimulated luminescence of $\text{Al}_2\text{O}_3\text{:C}$. *Radiat. Prot. Dosim.*, 100 (2002) 255.
4. M.S. Akselrod, V.S. Kortov, D.J. Kravetsky and V.I. Gotlib, Highly sensitive thermoluminescent anion defective $\alpha\text{-Al}_2\text{O}_3\text{:C}$ single crystal detectors. *Radiat. Prot. Dosim.*, 32 (1990) 15.



DR. HOMI BHABHA CENTENARY YEAR

5. K.H.Lee and J.H. Crawford, Jr., "Luminescence of the F center in sapphire. *Phys. Rev. B* 19 (1979) 3217.
6. B.D. Evans and M. Stapelbrock, "Optical properties of the F+ center in crystalline alumina. *Phys. Rev. B* 18 (1978) 7089.
7. L.E.Colyott, M.S.Akselrod, S.W.S.McKeever, Phototransferred Thermoluminescence in Alpha- $\text{Al}_2\text{O}_3\text{:C}$ *Radiat. Prot. Dosim.* 65 (1996) 263.
8. G. Molnar, J. Borossay, M. Benabdesselam, P. lacconi, D.Lapraz, K.Suvegh and A.Vertes Oxidation/Reduction Effects on the Thermoluminescence of $\alpha\text{-Al}_2\text{O}_3$ Single Crystals. *Phys. Status Solidi A* 179 (2000) 249-260.
9. E. Papin, P. Grosseau, B. Guilhot, M. Benabdesselam and P. lacconi. Influence of Point Defects on the Thermoluminescence of $\alpha\text{-Al}_2\text{O}_3\text{:C}$: Application to Dosimetry. *Radiat. Prot. Dosim.* 84 (1999) 91.
10. K.P.Muthe, K.Sudarshan, P.K.Pujari, M.S.Kulkarni, N.S.Rawat, B.C.Bhatt and S.K.Gupta. Positron annihilation and thermoluminescence studies of thermally induced defects in $\alpha\text{-Al}_2\text{O}_3$ single crystals. *J. Phys. D: Appl. Phys.* 42 (2009) 105405.
11. M.S.Kulkarni, D.R.Mishra, K.P.Muthe, Ajay Singh, M. Roy, S.K.Gupta and S.Kannan, "An alternative method of preparation of dosimetric grade $\alpha\text{-Al}_2\text{O}_3\text{:C}$ by vacuum- assisted post - growth thermal impurification technique." *Radiat. Meas.*, 39 (2005) 277.
12. D.R.Mishra, M.S.Kulkarni, K.P.Muthe, C.Thinaharan, M.Roy, S.K. Kulashreshtha, S.Kannan, B.C.Bhatt, S.K.Gupta and D.N.Sharma, "Luminescence properties of $\alpha\text{-Al}_2\text{O}_3\text{:C}$ crystal with intense low temperature TL peak." *Radiat. Meas.*, 42 (2007) 170 .
13. K.P. Muthe, M.S. Kulkarni, N.S. Rawat, D.R. Mishra, B.C. Bhatt, Ajay Singh, and S.K. Gupta, "Melt processing of alumina in graphite ambient for dosimetric applications." *J. Luminescence* 128 (2008) 445.
14. M.S.Kulkarni, D.R.Mishra and D.N.Sarma. A versatile integrated system for thermoluminescence and optically stimulated luminescence measurements. *Nucl. Instr. and Meth. in Phys. Res. B* 262 (2007) 384.

PLC-BASED PNEUMATIC CONTROL SYSTEM FOR CESIUM FOOD IRRADIATOR

M. Chandra, K. Mahajan and R.L. Suthar
Centre for Design and Manufacture

Introduction

The Cesium Food Irradiator was installed and commissioned in the Food Technology Division (FTD), in the year 1969, in collaboration with U.S. Atomic Energy Commission. The system was used by food technologists, for their various R&D programmes. The movement of the doors and the radiation source of the Irradiator were controlled by a Pneumatic Control system, with suitable safety logics. The very complex pneumatic system had failed a few years back and the movement of the doors and the radiation source were not proper and so the Irradiator was unfit for operation. The facility could not be repaired and put to use for shortage of expensive imported spares and expertise. CDM was entrusted with the task of refurbishment of this facility.

CDM undertook the work of refurbishment of the complete Irradiator and its control system. The source and door movement mechanisms were in badly rusted condition. These were serviced and refurbished with suitable new components. The Pneumatic Control system and its Programmable Logic Control (PLC) logics were designed, with many additional features and a safety interlocking system. PLC-based pneumatic control panel (Fig. 1) was designed, manufactured with indigenous components, integrated with sensors and limit switches and commissioned. The irradiator was inspected by the Safety Committee for Radiological Operations (SCRO) and given clearance for regular use on May 08, 2009.



Fig. 1 : Cesium Food Irradiator with PLC-based pneumatic control panel

Construction

Cesium Food Irradiator is a self-contained, lead shielded unit, weighing approximately 19 tons and occupying about 6.5 square meters of floor space. It uses the "moving source" principle. Briefly, the source moves from its storage cask into the irradiation chamber and goes back to its "stored" (home) position, after each radiation cycle. This principle eliminates a package carrier system with its inherent limitations on the size of packages that can be irradiated.

The 1,00,000 Curie source consists of 28 BNL standard Cesium¹³⁷ sources. The source plaques are contained in a lead shielded cask, which is attached to the irradiation chamber. The irradiation chamber is fabricated in several interlocking pieces in a clamshell type arrangement, which lends itself to



DR. HOMI BHABHA CENTENARY YEAR

ease of assembly. The individual components range in weight from approximately 1 ton for the base to 5.5 tons for the shielded cask. All the components are equipped with removable eyebolts.

The usable space in the two chambers consists of 200 mm height, 680 mm width and 1370 mm length. A pair of lead shielded doors provides access to the chamber. Ball screws operate the doors and the source plaque is moved back and forth in a horizontal plane, using a motorized lead screw. The source plaque travels on two case hardened stainless steel shafts and four linear ball bush bearings. Mechanical and PLC interlocks, monitor the movements of the source plaque and the doors, preventing accidental exposure of the operators.

Materials of construction are basically carbon steel for all outside surfaces and support members, stainless

steel for all inside surfaces and the source plaque. Lead and Heavy metals are used for shielding. The source plaque assembly and the shielding doors comprise the moving parts of the Irradiator. These are powered by compressed air and controlled by the PLC system.

CDM had carried out the refurbishment of the Irradiator (even when the Cesium¹³⁷ source was inside the Irradiator). Door and source movements are sensed by proximity sensors and limit switches, which are connected in series, to ensure additional safety. Optimized LCD pressure sensor is introduced in the pneumatic circuit. Extreme care was taken in the source motor circuit that under no circumstances the source will come out from its "stored" position when the door is in motion or in "opened" condition.

The meticulously designed PLC-based Pneumatic

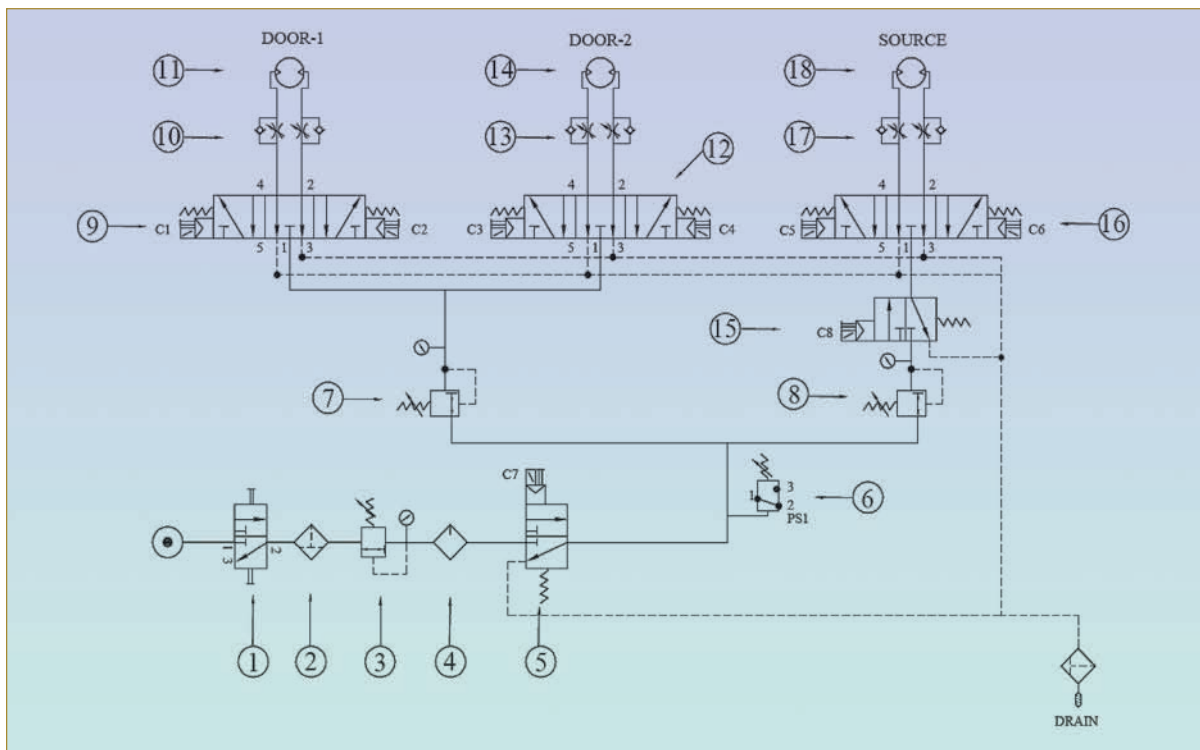

Fig. 2 : Pneumatic Control circuit for Cesium Food Irradiator (1) Hand slide valve; (2) Air filter; (3) Pressure regulator; (4) Lubricator; (5) & (15) 3/2-way valves; (6) Pressure switch; (7) & (8) Pressure control valves; (9), (12) & (16) 5/3-way valves; (10), (13) & (17) One-way flow control valve; (11), (14) & (18) Air motors

Control system (Ref. Fig. 2) has a Man Machine Interface (MMI), which will guide the operator to perform all the necessary steps involved in the irradiation operation. Light indicators are provided for door/doors and source movement separately. Hooter is provided to give alarm after completion of food irradiation or increase, if any, in surrounding radiation level.

Modes of Operation

The system has following modes of operations:

- Automatic Mode
- Manual Mode
- Emergency Mode
- Radiation Safe Mode
- Safe Return Operation

Automatic mode of operations

Source Exposure "time" is entered initially in MMI. The source will go back to its Home ("Stored") position after completion of the scheduled irradiation / exposure time.

Manual mode of operations

Source exposure time is controlled manually by the operator, with the help of a stopwatch. After the desired irradiating time, the operator with the help of an operating switch, takes source back to the Home ("Stored") position.

Emergency mode of operations

This operation is useful if the PLC system fails to function at any time. Source can then be taken back to its Home ("Stored") position. Doors can thereafter be operated, when the source is in Home ("Stored") position. This mode bypasses all the PLC programmes.

Radiation Safe mode of operation

Hooter makes alarm if the surrounding radiation level increases beyond 1 MR/hr. Source will be taken back to Home ("stored") position automatically, if the surrounding radiation level increases beyond 10 MR/hr.

Safe return operation

If electric and air supply systems fail, Source can be taken to Home ("Stored") Home position with the



Fig. 3 : Dr. S. Banerjee, Director BARC inaugurating the Cesium Food Irradiator

help of a ratchet arrangement, by rotating the Source Air Motor manually.

The control system of the Cesium Irradiator at FTD was inaugurated by Director, BARC on July 16, 2009. (Fig. 3). The PLC-based Food Irradiator will be safe for use by the food technologists and will ensure precise exposure time (to the accuracy of one second), for the food / items to be irradiated.



DR. HOMI BHABHA CENTENARY YEAR

STATEMENT BY DR. ANIL KAKODKAR, CHAIRMAN, ATOMIC ENERGY COMMISSION AND LEADER OF THE INDIAN DELEGATION AT THE 53RD GENERAL CONFERENCE OF IAEA, VIENNA, 16TH SEPTEMBER 2009



Dr. Anil Kakodkar, Chairman, Atomic Energy Commission, addressing the 49th General Conference of International Atomic Energy Agency at Vienna

“Madame President,

First of all, let me congratulate you on your election as the President of the 53rd General Conference. Under your able stewardship, and with the support of your team and the Secretariat of the Agency, this General Conference will be able to accomplish the many tasks before it.

I welcome the entry of Kingdom of Cambodia and the Republic of Rwanda to the membership of the International Atomic Energy Agency (IAEA). The expansion of our family is always a happy moment and I take this opportunity to convey our best wishes to each of our new members.

Madame President, this is a landmark year for the Agency. Dr. Mohamed ElBaradei, Director General, will be laying down office after his outstanding leadership of the International Atomic Energy Agency spanning the last 12 years. And if we look back further, it is has been a magnificent quarter century of his association with the work of the Agency. Through his tireless efforts, the IAEA has been able to meet the many challenges before it. Apart from being the chief navigator of the Agency, he has also been a friend, philosopher and guide to its member States at all times.

In these years, one quality that can be said to define Dr. ElBaradei, perhaps more than anything else, is his constant personal concern and compassion towards humankind and the link he made between ‘security’ and ‘poverty alleviation’. Indeed, when development

needs remain unaddressed, the resulting misery often leads to conflicts and violence, which in turn further affect development efforts and impact on regional and global stability.

I take this opportunity to express our gratitude to Dr. ElBaradei for his outstanding leadership of IAEA and indeed all his efforts to make this world a better place. I wish Dr. ElBaradei a life of good health and happiness and one of continuing association with the Agency.

I also have immense pleasure in welcoming H.E. Mr. Yukiya Amano who will take over the reins from Dr. ElBaradei shortly. Mr. Amano brings with him his vast experience and exceptional diplomatic skills. I join others in conveying our best wishes as he prepares for this new responsibility and assure him of our support in accelerating and enlarging the contribution of atomic energy to peace, health and prosperity throughout the world.

Role of atomic energy has become more relevant today than at any time before. There are several factors that dictate such a paradigm. Depleting earth resources and threat to global climate on one hand and the potential of nuclear energy to provide a large sustainable source of energy with negligible green house gas emissions that can address the development aspirations of a large part of humanity on the other being the major ones. There are however still some major barriers. Concerns on safety, proliferation and security as well as uncertainty in terms of assured fuel and other supplies over the lifetime of the plants would need credible and universally acceptable approaches before nuclear energy can play a role upto its full potential. In our view unless all related issues are addressed in a holistic manner, we are unlikely to reach a satisfactory solution. Compartmentalised approaches to safety, safeguards and security are unlikely to be sustainable in a scenario of expanding deployment of nuclear energy. We need technological solutions to reduce the risks arising from these factors.

We must also recognize that there is considerable urgency about our effective actions both in terms of access to means for development in under- developed areas of the world and reductions of carbon dioxide emissions. Concurrent progress on both these fronts is crucial to contain human conflicts and climate related disasters and prevent them from reaching a state of irreversible instability. Clearly, the IAEA and all its member states have a major responsibility towards reaching universally applicable solutions that are accessible to all. The importance of nuclear power in India was recognized right since our independence in the year 1947. India has been pursuing a comprehensive programme in atomic energy covering the entire fuel cycle involving uranium, plutonium and thorium based fuels. While the three stage development of our nuclear programme is dictated by our prime long-term objective of realizing energy independence on the basis of our vast thorium resources, our understanding and experience with thorium clearly reveals several benefits of the thorium fuel cycle, particularly in heavy water reactors, in terms of proliferation resistant nuclear energy production as well as efficient fissile plutonium disposal. These features of a thorium based fuel cycle may also be of interest to other countries.

The 300 MWe Advanced Heavy Water Reactor (AHWR) being developed in India is mainly a thorium fuelled reactor with several advanced passive safety features. The safety features in its design would enable meeting next generation safety requirements such as three days grace period for operator response, elimination of the need for exclusion zone beyond the plant boundary, hundred year design life and high level of fault tolerance. The advanced safety characteristics of this reactor like Passive Containment Cooling System and Gravity Driven Water Pool have been verified in a series of experiments carried out in full scale test facilities. The reactor is manageable with modest industrial infrastructure within the reach of developing countries. Also, for the same amount of energy produced,



DR. HOMI BHABHA CENTENARY YEAR

the quantity of long-lived minor actinides generated is nearly half of that produced in current generation Light Water Reactors. Importantly, high level of radioactivity in the fissile and fertile materials recovered from the spent fuel of AHWR and their isotopic composition preclude the use of these materials for nuclear weapons. Further, high level of fault tolerance provides for a much greater immunity even from insider threat. These features therefore, offer enhanced intrinsic proliferation resistant characteristics and high security strength.

A new version of AHWR named, Advanced Heavy Water Reactor – Low Enriched Uranium (AHWR-LEU) that uses low enriched uranium along with thorium as fuel has also been designed recently. The reactor has a significantly lower requirement of mined uranium per unit energy produced as compared to most of the current generation thermal reactors. This version of the design also can meet the requirement of medium sized reactors, in countries with small grids while meeting the requirements of next generation systems. While we strongly advocate recycle option, AHWR-LEU would also compete very favourably even in once through mode of fuel cycle. (A brochure of AHWR-LEU has been made available at this conference).

High level radioactive waste disposal is another issue that needs attention. While we consider recycle option backed up by immobilization of residual waste in inert matrices as a proven technological option for safe geological disposal, there is perhaps a need to develop partition and transmutation technologies that will reduce the radioactive half life of the waste to a level wherein most of the radioactivity is lost within a practical time frame comparable with life span of institutions that are required to manage them. Clearly this necessitates intense research and development. Given the level of understanding and development that we have reached today, it seems to me that this is a realizable goal.

Madame President, an important objective and guiding principle of the Agency in its work is to foster the exchange of scientific and technical information on peaceful uses of atomic energy. Here, I reiterate India's commitment to make a significant contribution to the growth of nuclear energy globally within the framework of IAEA.

I would now like to present some other achievements of the Indian nuclear power programme, which has by now clocked over 300 reactor years of safe and economic nuclear power generation. The Enmasse Feeder Replacement (EMFR) for RAPS-2 has been completed with highest degree of safety. This complex and technologically advanced project was carried out with entirely indigenously developed technology. India is one of the few countries in the world which have experience in the ageing management of nuclear power plants. Our PHWR units offer a wide range of possibilities in the small and medium reactor category with proven performance and cost competitive advantage.

Construction has been almost completed of three 220 MWe Pressurised Heavy Water Reactors (KAIGA-4 and RAPS 5 & 6) while two 1000 MWe Light Water Reactors and one 500 MWe Prototype Fast Breeder Reactor (PFBR) are currently in advanced stages of construction. The unit size of Indian Pressurised Heavy Water Reactors have been further increased to 700 MWe and a series of such units are planned for installation in the country. Our Fast Breeder Test Reactor (FBTR) has successfully achieved yet another milestone with its unique (U,Pu)C fuel crossing 165 GWd/tonne burnup without any fuel failure. PFBR fuel which is under irradiation testing in FBTR has reached a burnup of 90 GWD/tonne.

Madame President, India's indigenous programme is set to accelerate. At the same time, India looks forward to mutually beneficial two-way nuclear cooperation with other members of the IAEA. Last year was a year of intense diplomatic activity in which India and other

friendly countries with advanced nuclear technologies worked closely in order to consolidate the framework for cooperation. We are presently in the process of reformulating our plans for the larger scale programme implementation taking advantage of new possibilities that are emerging. This year is already a time for results and RAPS-2 (200 MW) is our first Pressurised Heavy Water Reactor that is operational using imported natural uranium.

Nuclear energy not only lights up bulbs and drives machines, but also has applications in medical field for raising food production and water management. Therefore, these areas need special thrust. During the 2007 IAEA General Conference, India offered a new Bhabhatron-II Teletherapy unit to the Socialist Republic of Vietnam under the Programme of Action for Cancer Therapy (PACT) of the IAEA. We are happy to report that Bhabhatron teletherapy unit was dispatched to Vietnam in August, 2009 and the high-capacity telecobalt source for this machine is also ready for shipment.

This year, two new mutant varieties were notified for commercial cultivation taking the total number of mutant varieties developed by Bhabha Atomic Research Centre (BARC) using nuclear techniques to 37. The interest of entrepreneurs in using radiation technology for hygenising and preserving food and allied products is increasing and 15 such facilities are now operational in India with some more under construction. Radiation technology has also helped India in increasing its exports of food items including to the most developed markets in the world.

Water is the basis for life and the greatest human civilizations have developed around water bodies. Not surprisingly, when we look for signs of life on other planets, we begin with the search for signs of water. And yet, if there is one crisis that threatens each one of us, it is the declining access to water. Our hybrid Nuclear Desalination Demonstration Plant (NDDP) at Kalpakkam, comprising of Reverse

Osmosis (RO) based unit of 1.8 million litres per day commissioned in 2002 and a Multi Stage Flash (MSF) desalination plant of 4.5 million litres per day as well as a barge mounted RO desalination unit commissioned recently would help in dealing with the shortage of water in our water-stressed coastal areas. Rejuvenation of springs that are the sources of drinking water in villages on the foothills of Himalayas through use of isotope hydrology techniques is another example of the important role atomic energy can play in this vital area.

Madame President, as I have said earlier, we are now in an era where reserves of fossil fuels are finite and concerns regarding climate change and sustainable development are paramount. This is indeed the nuclear age and the challenge is to meet the enormous expectations of mankind from IAEA in the 21st century. It is India's firm belief that there is no substitute for intensifying joint collaborative activity within IAEA and we have, for instance attached the highest importance to INPRO from the time this programme commenced in 2001. There is the need for all member states to pool in resources and experience in the best interest of mankind. Such collaborative activities should be in the form of participative partnerships that lead to capacity building and grass root level participation of all stakeholders.

In the final analysis, IAEA's success in intensifying the use of nuclear energy in the service of mankind is dependent on urgent action to develop human resources in adequate numbers. One of the biggest limitations to expansion of nuclear power, particularly in countries only now looking in this direction, is the lack of qualified manpower. India is willing to do its bit here in working with friendly developing countries.

Madame President, we are now coming to the end of the Homi Bhabha Birth Centenary year and I am happy to inform you that an international conference on "Peaceful Uses of Atomic Energy" will be held in New Delhi from 29 September to 1 October, 2009. I thank



DR. HOMI BHABHA CENTENARY YEAR

IAEA for its support to this conference. I take this opportunity to recall the words of the father of India's nuclear programme, Dr. Homi Bhabha, as President of the International Conference on Atomic Energy for Peaceful Uses at Geneva in 1955. He said,

“For the full industrialization of the underdeveloped countries, for the continuation of our civilization and its further development, atomic energy is not merely an aid, it is an absolute necessity. The acquisition by man of the knowledge of how to release and use atomic energy must be recognized as the third epoch of human history”.

Thank you, Madame President.”

FORTHCOMING CONFERENCE

InDA-APDA Conference on Desalination and Water Purification (InDACON-2010)

The Board of Research in Nuclear Sciences, in association with the Indian Desalination Association (InDA) and the Asia-Pacific Desalination Association (APDA) will be hosting the above conference, at Chennai, from March 10-12, 2010. The objective of the conference, is to review developments in desalination and water purification technologies and identify key elements, in formulating an integrated water management philosophy, to provide fresh water at affordable cost. The Scientific programme of the conference includes Oral & Poster presentations as well as invited talks. The topics that would be covered include:

Integrated Water Management Schemes for supply of purified water; Developments in Desalination & Water Recovery Technologies; Nuclear Desalination & Water Treatment Systems; Hybrid Desalination & Water Treatment Systems; Membrane Development; Membrane Processes for Water Purification & Treatment; Nano-technology for Water Purification; Safe Drinking Water Technologies & Deployment Methodologies; Use of Non-conventional Energy Sources for Desalination & Water Purification; Environmental Issues in Desalination & Water Purification; Financial Aspects; Economics and affordability of desalination & Water Purification Systems; Role of NGOs and Private Trusts in providing safe drinking water.

Address for Communication :

Mr. S. Prabhakar

Secretary, Organizing Committee (InDACON-2010)
Head, Separation Technology Section
Desalination Division
BARC, Trombay, Mumbai - 400 085.
Tel (O) : +91-22-25594647
E-mail : sprabha50@rediffmail.com

Mr. V.K. Srivastava

Head, Thermal Desalination Section
Desalination Division
BARC, Trombay, Mumbai - 400 085.
Tel (O) : +91-22-25594649
E-mail : vkshiv@barc.gov.in

भा.प.अ. केंद्र के वैज्ञानिकों को सम्मान BARC SCIENTISTS HONOURED



Dr. B. N. Pandey

डॉ. बी.एन. पांडे को रिसर्च सोसाइटी द्वारा प्रकाशित एक प्रतिष्ठित अंतर्राष्ट्रीय पत्रिका 'रेडियेशन रिसर्च' हेतु पोटकास्ट मंडल के सदस्य की हेसियत से सेवाकार्य करने हेतु नामांकित किया गया है। आप दुनिया के विभिन्न भागों के नामांकित सदस्यों में से एक हैं। यह मंडल रेडियेशन रिसर्च के

प्रकाशित प्रति अंक हेतु किसी एक विषय पर इंटरव्यू का संचालन कर किसी एक को समाचार झलकियों एवं पत्रिकाओं में प्रसारित करते हैं। समय - समय यह मंडल उल्लेखनीय वैज्ञानिक वर्तमान विषयों पर गोष्ठी करते हैं। यह गोष्ठियां डब्लूडब्लूडब्लू राडूस.ओ.ऑरजी अथवा एचटीटीपी://आइएसएमआर 1.एलबीएल.जीओवी:8080 / एक्सडब्लूआइकेआइ /बीआइएन/ विव /रेडियेशन + रिसर्च + सोसाइटी /

डॉ. पांडे ने 1994-95 में जीव-एवं रेडियो जीव -विज्ञान में ऑरियंटेशन पाठ्यक्रम के 38वें बैच से स्नातकता प्राप्त करके वर्ष 1995 में विकिरण जीव-विज्ञान एवं स्वास्थ्य -विज्ञान प्रभाग में कार्यभार संभाला। इन्होंने वर्ष 2003 में मुंबई विश्वविद्यालय से लाइफ साइंसिज़ में पीएच.डी की डिग्री प्राप्त की। वर्ष 2004-05 में रेडियोलोजी विभाग न्यू जरसी मेडिकल स्कूल, न्यूयार्क, यूएसए के रेडियेशन रिसर्च प्रभाग में प्रोफेसर ई.आइ. आजम के साथ पोस्ट डाक्टरल फेलोशिप किया। इस समय आप केन्सर एवं रेडियेशन ब्योलोजी के क्षेत्र के काम में व्यस्त रहें हैं। वर्तमान में आपकी रुचि में इफेक्ट ऑफ लो एन्ड हाई एलईटी रेडियेशन ऑन नॉर्मल एन्ड ट्यूमर स्यलज़, फॉर सेल्यूलर रेडियो -प्रोटेक्शन एन्ड इंप्रूवरेडियेशन रिसर्चड मेंट ऑफ केन्सर रेडियोथेरेपी शामिल है।

Dr. B.N. Pandey has been nominated to serve as Member, Podcast Committee for the prestigious 'Radiation Research', an International Journal published by Radiation Research Society, USA. He is one of the members out of six nominated from different parts of the world. The Committee serves to conduct interviews on the theme/subject of one of the published papers selected from each issue of 'Radiation Research'. These interviews get broadcasted along with a not from the Editor-in-Chief of the Journal and other news highlights. Moreover, periodically, the Committee also conducts interviews with eminent scientists on current topics of radiation research. These interviews can be heard at www.radres.org or <http://lsmr1.lbl.gov:8080/xwiki/bin/view/Radiation+Research+Society/>

Dr. Pandey joined the Radiation Biology and Health Sciences Division in 1995 after Graduation from the 38th Batch of Biology-Radiobiology Orientation Course (1994-95). He received his Ph.D. in Life Sciences from Mumbai University in 2003. He completed his Post Doctoral Fellowship with Prof. E.I. Azzam at the Division of Radiation Reserach, Department of Radiology, New Jersey Medical School, Newark, USA in 2004-05. Currently, he is working in the field of Cancer and Radiation Biology. His current research interest involves effect of low and high LET radiation on normal and tumour cells, for cellular radio-protection and improvement of cancer radiotherapy.



Sketch by Dr. Homi J. Bhabha

Edited & Published by:

Dr. Vijai Kumar,

Associate Director, Knowledge Management Group &

Head, Scientific Information Resource Division,

Bhabha Atomic Research Centre, Trombay, Mumbai 400 085, India.

Editorial Management: Dr. (Ms.) S. C. Deokattey,

Computer Graphics & Layout: Mr. B.S. Chavan, SIRD, BARC

BARC Newsletter is also available at

URL: <http://www.barc.gov.in>