

बी ए आर सी न्यूज़लैटर

BARC NEWSLETTER

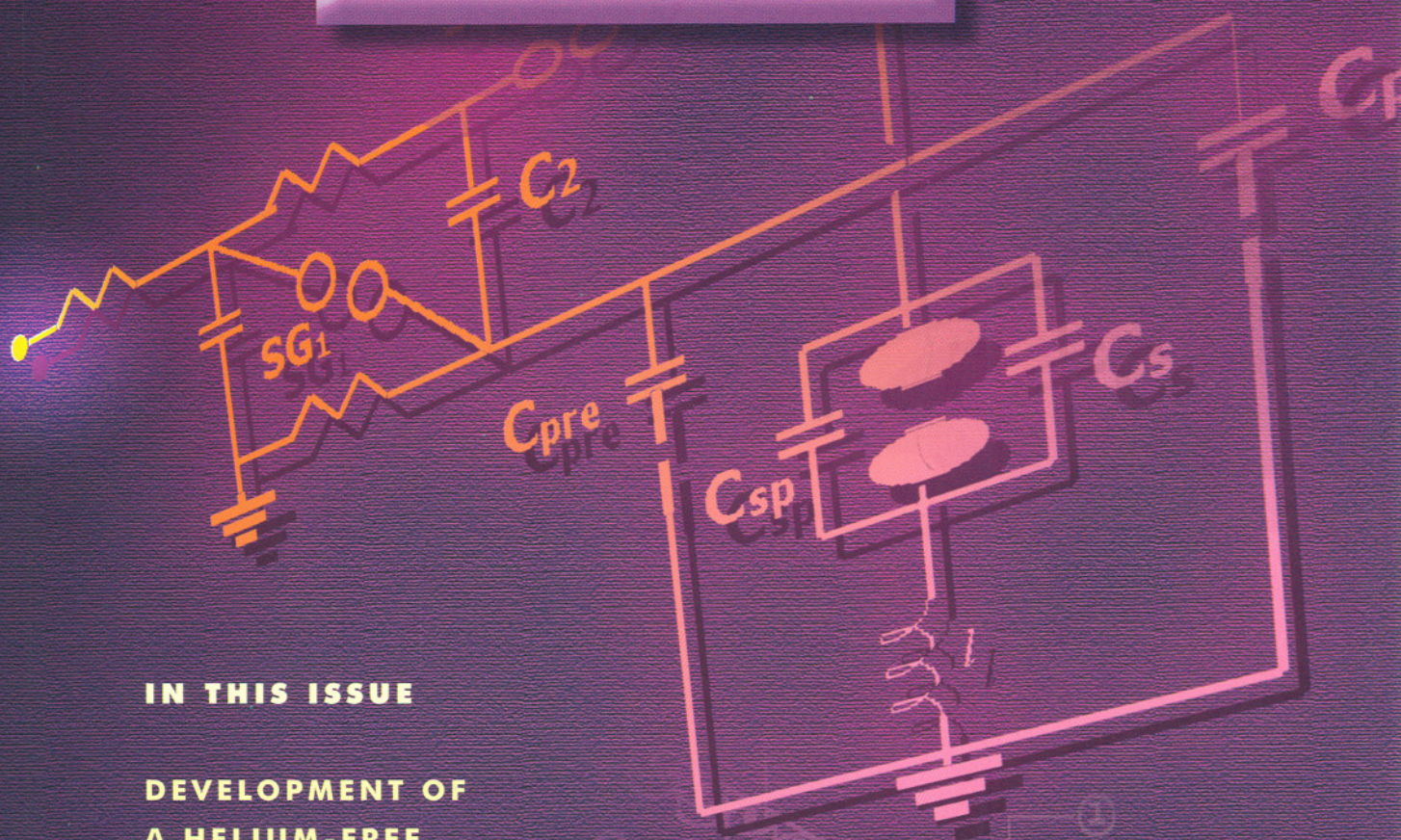

IN THIS ISSUE

DEVELOPMENT OF
A HELIUM-FREE
ATMOSPHERIC PRESSURE
PULSED CO₂ LASER

A REGIONAL NUCLEAR
DATA MIRROR WEB SITE

DEVELOPMENT OF
AN ELLIPTICAL
CRYSTAL BENDER

②

④

⑤

⑥

भाभा परमाणु अनुसंधान केंद्र Bhabha Atomic Research Centre



पंडित जवाहरलाल नेहरू द्वारा परमाणु ऊर्जा संस्थान, ट्रॉम्बे (जिसका बाद में श्रीमती इंदिरा गांधी द्वारा दिनांक 12 जनवरी 1967 को भाभा परमाणु अनुसंधान केंद्र के रूप में पुनर्नामन किया गया) का दिनांक 20 जनवरी 1957 को औपचारिक उद्घाटन किया गया था.

Atomic Energy Establishment Trombay (later renamed as Bhabha Atomic Research Centre on 12 January 1967 by Smt. Indira Gandhi) was formally inaugurated by Pandit Jawaharlal Nehru on 20 January 1957.

CONTENTS

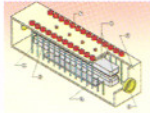

Development of a Helium-free atmospheric pressure pulsed CO₂ laser

2

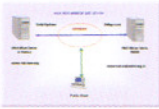

A regional IAEA-NDS nuclear data mirror site in India for the Asian region

9



Development of an elliptical crystal bender

22



Handing over of major equipment for the AHWR critical facility

24



BARC Transfers Technologies for "TLD phosphor and TLD badge "

27



Workshop on Thermal Analysis Techniques: A Report

29



DAE-BRNS National Symposium and Workshop on 'Thermal Analysis'

31



DAE-BRNS Solid State Physics Symposium (Golden Jubilee Event: December 5 – 9, 2005)

33

भा.प.अ. केंद्र के वैज्ञानिकों को सम्मान
BARC Scientists Honoured

36

URL : <http://www.barc.gov.in>

DEVELOPMENT OF A HELIUM-FREE ATMOSPHERIC PRESSURE PULSED CO₂ LASER

(granted US Patent no. 6,950,453)

D. J. Biswas and J. P. Nilaya
Laser & Plasma Technology Division
and
Aniruddha Kumar
Advanced Fuel Fabrication Facility, Tarapur

Introduction

The major role of helium in the pulsed atmospheric pressure operation of a transversely excited CO₂ laser, commonly termed as TEA CO₂ laser, is to stabilise the discharge. Helium, with its very low electron affinity, facilitates the occurrence of an arc-free discharge at higher operating pressures and hence has been indispensable in the conventional operation of TEA CO₂ lasers. Helium, which constitutes majority of a CO₂ laser gas mixture, is expensive and scarce. A number of special techniques have, therefore, been employed in the past, to obtain helium-free operation of CO₂ lasers. These methods and their limitations are briefly described below:

1. Low pressure CO₂ laser: Helium-free operation has been successfully achieved in TE CO₂ lasers [1, 2] at sub-atmospheric pressures or low pressure synchronous longitudinal discharges [3] or CW operation of low pressure CO₂ lasers [4]. While the variations in the excitation circuits allowed helium-free operation in TE systems, albeit below atmospheric pressure, the low operating pressure in CW systems intrinsically ensures, glow mode operation of the discharge in the absence of helium.

Due to the sub-atmospheric pressure operation of these systems, the maximum coherent power that can be obtained from them, is always lower than TEA systems with similar active volume.

2. Rapid discharge technique: This approach [5-7] takes advantage of a very rapid discharge (few tens of nsec as against hundreds of nsec in a conventional operation) to realise helium-free operation, as the glow-to-arc transition in the absence of helium is very fast. Thus the discharge extinguishes before arcing can set in.

Helium-free operation by rapid discharge technique, can be effected only in specially designed mini laser systems, that inherently offer low discharge loop inductance. Such operation, therefore, restricts the active volume and hence also reduces the maximum obtainable energy output from the system. Rapid excitation invariably results in the emission of optical pulses of short duration. Conventional long pulse operation is therefore not possible by this method.

3. Seeding the laser gas mixture with Low Ionisation Potential (LIP) additives: In the absence of helium, the electrons in the discharge are lost largely by negative ion attachment processes, giving rise to the formation of an arc discharge. The addition of LIP

hydrocarbons increases the primary photoelectron density thereby compensating the loss of electrons in the absence of helium, leading to arc-free operation [8].

The LIP additives seeded in the laser gas mixture undergo dissociation in an electric discharge and tend to settle on the optics, electrode and the internal surface of the laser head, rapidly degrading the performance of the laser.

4. Preconditioning the inter-electrode volume, by electrons from an external source: Loss of electrons in the absence of helium can be overcome by deluging the active volume, with electrons produced externally, as in the case of an electron beam controlled CO₂ laser, resulting in arc-free operation [9]. In this system, helium-free operation of TEA CO₂ lasers, calls for an external source of electrons, thereby making the system more complicated, expensive and bulky. Moreover, this is achieved at the expense of the wall plug efficiency.

We describe here helium-free operation of a conventional TEA CO₂ laser, which has been achieved in systems where the active volume ranged from ~1 cc to ~200 cc and was irrespective of i) the geometry of electrodes, viz., profiled, un-profiled or cylindrical, ii) the type of ballasting used for preionisation viz., resistive, inductive or capacitive and iii) the location of the preioniser, viz., beneath the semi-transparent electrode or along the side/sides of the electrodes [10]. This was rendered possible by integrating the spiker and sustainer-like actions, into a single pulser network, by making use of a coupling inductance. Another important advantage of this excitation circuit is its simplicity. A single source powers and a single switch controls the preionisation, the spiker and the sustainer discharges.

Experimental System

As stated before, helium-free operation has been achieved in a wide variety of systems, but we describe here in

detail, the operation of a medium sized TEA CO₂ laser, with contoured electrodes. A 3-dimensional view of the laser head is shown in Fig. 1. It consists of two Ernst profiled [11] electrodes, which define a discharge cross section of 1.5 × 1.5 cm² and a length of 30 cm. Preconditioning of the laser gas mixture is accomplished, by creating auxiliary spark discharges between brass preionising pins (14 pairs on either side) placed at regular intervals, along the length of the discharge and at a distance of 5 cm from its centre. The entire assembly is housed in a leak tight Perspex chamber (36 cm × 12 cm × 15 cm) the ends of which are 'O'ring sealed with a concave 4 m ROC gold coated mirror and a ZnSe Brewster window. A 70% reflective ZnSe plane output mirror, together with the gold-coated mirror defines the 65 cm long optical cavity. The flow of current through each of the auxiliary sparks is limited by connecting a small capacitance in series with it.

The schematic of the excitation technique, employed to operate the TEA CO₂ laser, wherein the spiker and sustainer like actions have been integrated into a single pulser network with the help of a coupling inductance (*l*), is shown in Fig. 2. Such an integration has made possible a single source to power and a single switch driven pulser to control all the three discharges, viz., the pre, the spiker and the sustainer discharges as against the conventional spiker sustainer excitation scheme, that requires two sources and two switches to achieve the same [10]. The usage of a two-stage Marx generator allows the condenser C₁, on closure of the switch SG₁, to power the pre-discharge. Alongside the preionisation, on closure of SG₂, the main condensers C₁ and C₂ come in series and charge transfer through the inductance, causes the voltage across the spiker condenser C_{sp}, to build up rapidly as shown in Fig. 3 (a). Fig. 3 (b) represents the current flowing from the main condensers following the closure of the spark gap SG₂. The first forward cycle

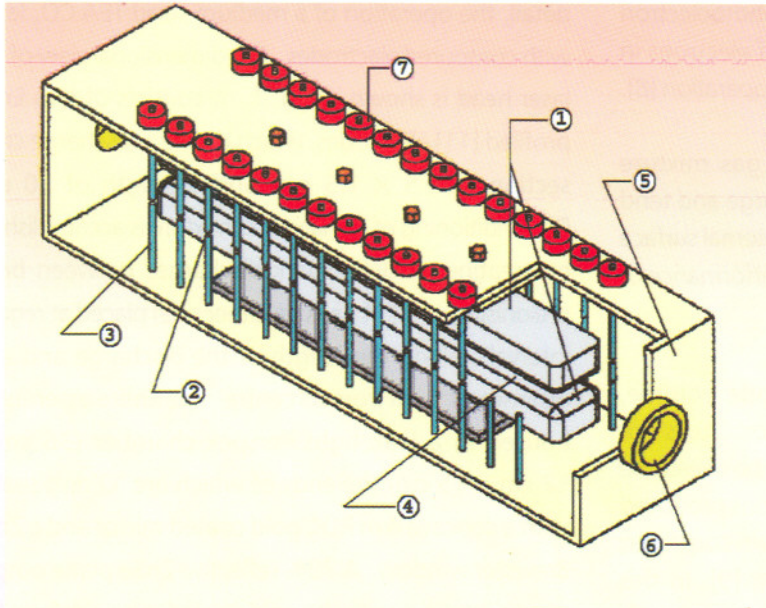

Fig. 1: Three-dimensional view of the laser head.
1. Uniform field electrodes 2. Preionisation gap 3. Preionisation pins
4. Inter-electrode gap 5. Perspex housing 6. Cavity mirror
7. Preionisation capacitors.

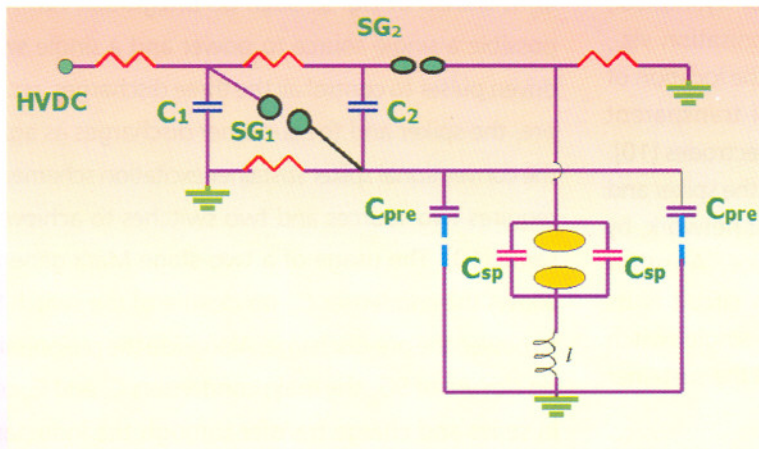

Fig. 2: Schematic of the excitation circuit for helium-free operation of a TEA CO₂ laser.

of the current pulse, charges up the spiker condenser C_{sp} to its peak voltage. As this high voltage impulse is impressed across the inter electrode gap, it closes, leading to the flow of the spiker current. The presence of inductance in the spiker charge-up loop, automatically delays the main discharge, with respect to the pre discharge. This small delay can be readily measured from the temporal wave-forms of Fig. 3 and has also been corroborated by adopting the delay measuring method [12] based on the collection of light originating from the preioniser and main discharges separately. The initial voltage to which the main condensers are charged and the values of C_1 , C_2 , C_{pre} and C_{sp} are so chosen, that after the switching of the Marx Bank, the voltage across the preionised inter-electrode gap results in an E/N, appropriate for the initiation of the discharge. The reduced voltage across the main condenser, by virtue of its powering the preioniser discharge and spiker discharges, in conjunction with the inductance (l) maintains an E/N condition, suitable for the sustenance of the discharge. Decoupling of the two discharges viz., the spiker and the sustainer and the tailoring of the sustainer pulse by making use of the inductance, resulted in a condition where glow discharge

could be reliably obtained even in the absence of helium under a wide range of operating conditions. The inductance plays a very crucial role as it controls the delay between both pre and spiker as well as spiker and sustainer discharges, in addition to deciding the rate of rise in voltage across the electrodes.

Performance of the Laser

We monitored the energy, peak power and the FWHM value of the emitted laser pulse, as a function of the partial pressure of CO_2 gas, for a particular value of inductance. The results of these studies are summarized in Fig. 4 and Fig. 5. As can be seen, the most optimised performance of the laser in terms of its output energy, occurs for equal concentrations of CO_2 and N_2 (Fig. 4). The electro-optic efficiency is estimated to be $\sim 7\%$ after accounting for the residual energy in the condenser at the end of the discharge (Fig. 3 (a)).

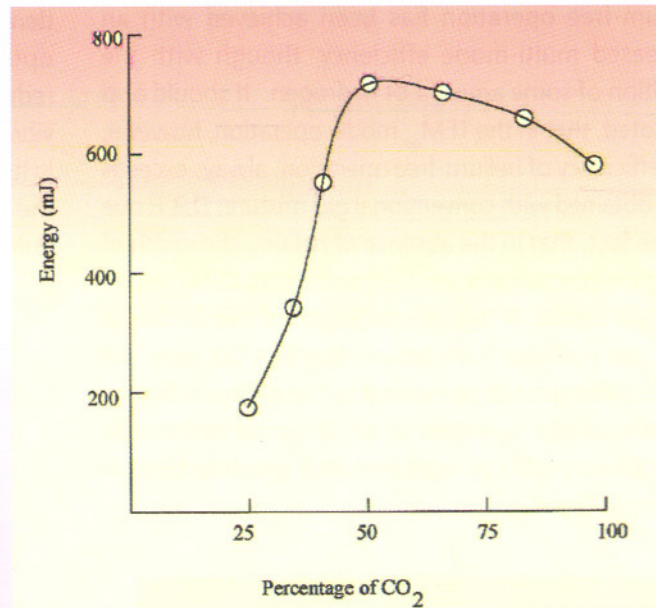

Fig. 4: Output energy of the laser as a function of the partial pressure of CO_2 gas.

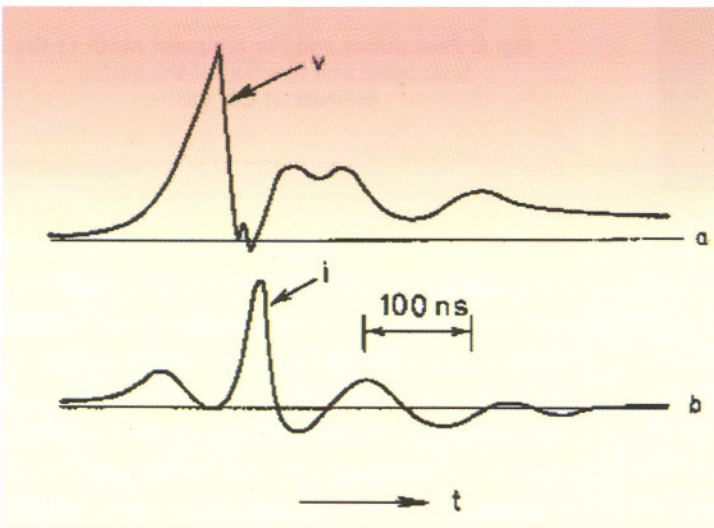

Fig. 3: (a) The voltage across the main discharge
(b) The current in the sustainer loop

The electro-optic efficiency is measured to be 7.8% for multi mode operation, when the same laser operates with conventional gas mixture ($\text{N}_2:\text{CO}_2:\text{He}::1:1:5$). It may be noted here, that the efficiency would be higher in both the cases, if the fraction of the stored energy expended in the preconditioning is also taken into account. Besides contributing to the stabilisation of the discharge, helium also helps in depopulating the lower laser level, thereby allowing the participation of the same CO_2 molecule in the lasing process more than once. Although this process, is slowed down in the absence of helium, owing to the large concentration of CO_2 molecules (50%) in the gas mixture, the electro-optic efficiency reduces only marginally. With only addition of small amount of hydrogen to the gas mixture ($\text{N}_2:\text{CO}_2:\text{H}_2::1:1.2:0.1$), the multimode efficiency increases to $\sim 8.8\%$. Thus

helium-free operation has been achieved with an increased multi-mode efficiency, though with the addition of some amount of hydrogen. It should also be noted, that in the TEM₀₀ mode operation, however, the efficiency of helium-free operation, always exceeds that obtained with conventional gas mixture. This is due to the fact, that in the absence of helium, the width of the glow discharge is less [13] and hence TEM₀₀ mode filling is better. A logical conclusion of this finding is that, the emission from helium-free TEA CO₂ laser will be less divergent as compared to the emission from a conventionally operated laser. A typical multimode laser beam profile as captured on a graphite block is shown in Fig. 5.

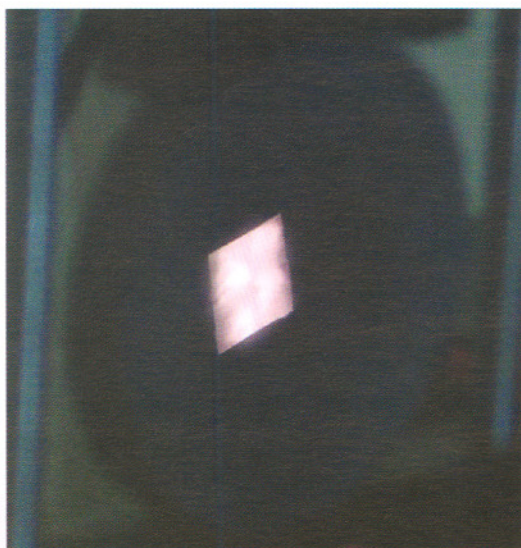

Fig. 5: The laser beam as seen on a graphite block.

The peak power, duration and energy of the laser pulse can be varied by varying the partial pressures of N₂ and CO₂ as shown in Fig. 6. As the concentration of CO₂ reduces from 92 % to 27 %, the FWHM value of the laser pulse increases (from 80 nsec to 590 nsec) by a factor of ~7.5, while the peak power drops by a factor of almost 5.25 (from ~2.84 MW to 0.54 MW). The peak power increases monotonically with increase in CO₂ concentration, revealing higher gain at higher

density of active molecules. The FWHM value of the optical pulse, on the other hand, increases with reduction in the concentration of CO₂. N₂ can hold vibrational energy for longer duration and any increase in its concentration, therefore, leads to the flattening of the pulse. Such large variation of the peak power and pulse width, is a direct consequence of utilising only

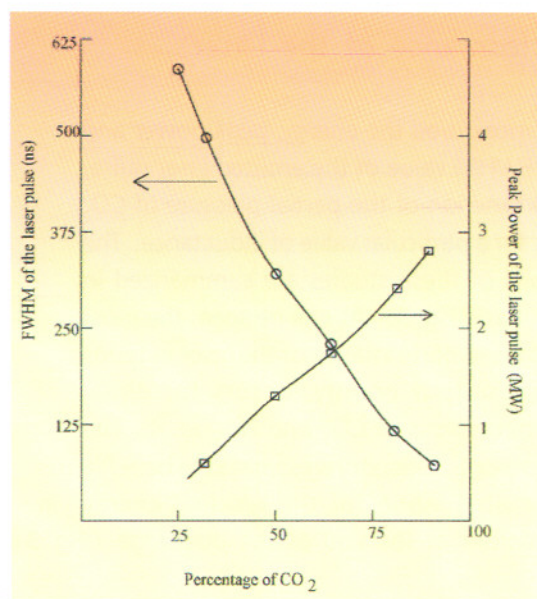

Fig. 6: Peak power and the temporal width of the laser pulse as a function of the partial pressure of CO₂ gas.

molecular gases for the operation of this laser. The same laser when operated with the conventional gas mixture, (consisting of helium), exhibits much smaller variation in the pulse duration with changing partial pressures of the molecular gases. As can be seen from Fig. 6, the FWHM value of the laser pulse when the present system is operated with conventional gas mixture, changes almost by a factor of ~1.6 (from 80 ns to 135 ns). It is also seen from Fig. 7, that the maximum peak power obtainable in this case is in general, lower than that obtainable with helium-free operation. The maximum value of small signal gain for this system, has been measured to be ~2.7 %/cm. The optimum value of the

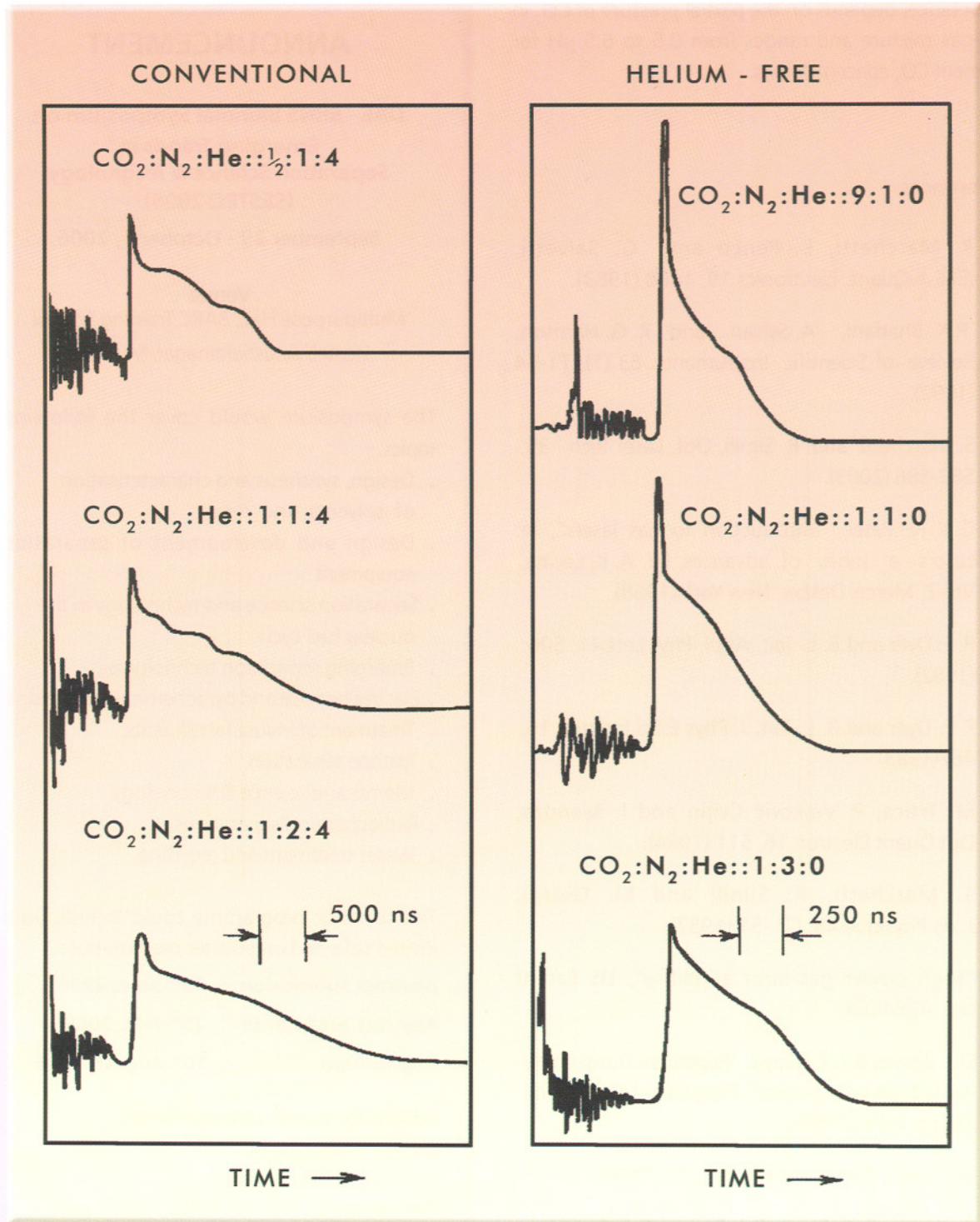

Fig. 7: Temporal shape of the laser pulse for conventional and helium-free operations, as a function of the gas composition.

inductance, depends on the partial pressure of CO₂ in the gas mixture and ranges from 0.5 to 6.5 μH for different CO₂ concentrations.

References

1. R. Marchetti, E. Penco and G. Salvetti, IEEE J. Quant. Electronics 19, 1488 (1983).
2. P. K. Bhadani, A. Sylvan and R. G. Harrison, Review of Scientific Instruments 63 (1), 71-74 (1992).
3. S. Marchetti and R. Simili, Opt. Laser Tech 35, 583-586 (2003).
4. C. K. N. Patel, "Introduction to gas lasers", In: Lasers - a series of advances, Ed. A. K. Levine, Vol-2, MerceL Dekker, New York (1968).
5. P. E. Dyer and B. L. Tait, Appl Phys Lett 41, 506 (1982).
6. P. E. Dyer and B. L. Tait, J. Phys E:Sci Instrum 16, 467(1983).
7. M. Trtica, P. Vujkovic Cvijin and I. Mendas, Opt Quant Electron 16, 511 (1984).
8. S. Marchetti, R. Simili and M. Giorgi, J. de Physique 48, C7 -51 (1987).
9. "High power gas laser amplifire", US Patent No. 4264868.
10. D.J. Biswas & J. P. Nilaya, "Repetitive Transversely excited gas laser pulsers", Prog Quant Electronics 26, pp 1-64 (2002).
11. G.J. Ernst, Opt Commun 49, 275 (1984).
12. A. Kumar, R. B. Bhatt, D.J. Biswas, N.S. Banerjee, A. Mokhriwale and U. Nundy, Meas Sci Technol 12, 1739 (2001).
13. P.E Dyer and B.L. Tait, Appl Phys Lett 41, 506 (1982).

ANNOUNCEMENT

DAE - BRNS Biennial Symposium on Emerging Trends in Separation Science & Technology (SESTEC-2006)

September 29 - October 1, 2006

Venue

Multipurpose Hall, BARC Training School
Hostel, Anushaktinagar, Mumbai

The symposium would cover the following topics.

- Design, synthesis and characterisation of solvents and resins.
- Design and development of separation equipment.
- Separation science and technology in the nuclear fuel cycle
- Emerging separation technologies.
- Electrochemical and pyrochemical separations.
- Treatment of industrial effluents.
- Isotope separation.
- Membrane science & technology.
- Radiochemical separations
- Water treatment and recycling.

The scientific programme could include both invited talks and oral/poster presentations.

Abstract Submission : 30th June, 2006

Abstract acceptance : 25th July, 2006

Registration : 10th August, 2006

Address for further correspondence :

Dr. P.K. Mohapatra,

Secretary SESTEC-2006

Radiochemistry Division, BARC,
Trombay, Mumbai 400085, India

Tel.: +91 22 25594571 . Fax : +91 22 25519613

E-mail : mpatra@barc.gov.in

web site : www.barc.gov.in/symposia/Sestec2006

A REGIONAL IAEA-NDS NUCLEAR DATA MIRROR SITE IN INDIA FOR THE ASIAN REGION

S. Ganesan and R. Srivenkatesan
Reactor Physics Design Division
and
C. S. R. C. Murthy and P. S. Dhekne
Computer Division

Introduction

Development of a knowledge base and providing accurate description of basic nuclear interactions, is a fundamental and natural part of the evolution of nuclear science and technology. As part of the inevitable necessity of knowledge-sharing on nuclear data (for various applications in nuclear physics), this paper presents an introduction to the online nuclear data services at Mumbai. The online nuclear data services (<http://www-nds.indcentre.org.in>) that mirror the nuclear data website of the International Atomic Energy Agency (IAEA), Vienna (<http://www-nds.iaea.org>), were commissioned in Mumbai, during the visit of the IAEA Director General Mr. Mohamed ElBaradei, on 15 November 2004. Several Indian diplomats and many distinguished members of the DAE family; Dr. A. Kakodkar, Chairman, DAE and Secretary to the Government of India, Dr. S. Banerjee, Director, BARC and Prof. R. Chidambaram, Principal Scientific Advisor to the Government of India and DAE Homi Bhabha Professor graced the event.

“Nuclear data” is a technical term that stands for quantitative, results of scientific investigations of the nuclear properties of matter. These numerical data describe quantitatively, the physics properties of atomic nuclei and the fundamental physical relationships governing their interactions, thereby characterizing the physical processes underlying all nuclear technologies.

On-line nuclear data services in India

A server is at present mirroring the nuclear data services of the IAEA, Vienna. Users can get all the nuclear data information, much faster from the nuclear data mirror website, which is now fully operational. Scientists are invited to make maximum use of this facility for recommended values of nuclear data, for use in research and other applications. Experimental groups in India, who have worked on basic nuclear data, are also welcome to code their nuclear data into the EXFOR system.

<http://www-nds.indcentre.org.in>

The scope of nuclear data collections includes all the 85 natural elements, 290 stable isotopes and more than 2500 radioactive nuclides.

For technical handling and convenience, nuclear data are commonly categorized into two main groups:

1. Nuclear reaction data, describing the interactions of various projectiles such as neutrons, protons or photons with target nuclei and
2. Nuclear structure and decay data, which provides numerical values of nuclear energy levels, half-lives and radioactive decay radiations.

Obviously, new concepts of reactor designs will have a sound scientific basis, if the nuclear data used are accurate. Applications of nuclear data include all areas of nuclear science and technology, covering energy applications (fission reactor design; nuclear fuel cycles; nuclear safety; reactor monitoring and fluence determination; waste disposal and transmutation; accelerator driven systems; fusion device design and plasma processing technologies) as well as non-energy applications (cancer radiotherapy; production of radioisotopes for medical and industrial applications; personnel dosimetry and radiation safety; nuclear safeguards; environmental monitoring and clean-up; materials analysis and process control; radiation damage studies; detection of concealed explosives and illegal drugs; exploration for oil and other minerals) and basic research (e.g. nuclear astrophysics) and education.

Conceptual studies of Accelerator Driven Sub-critical Systems (ADSS) have provided a fresh look at the use of thorium fuel cycle in a lead-bismuth coolant environment. The nuclear data requirements for ADSS, span energy ranges up to GeV levels, much beyond the 10 MeV limit, used for neutron energies in the design and operation of thermal reactor systems in India and the 15MeV limit, used for fast reactors. The basic data files available from the Indian Mirror site for fusion, fast

and thermal reactor applications go up to 20 MeV. A number of additional reaction channels open at higher energies. The mirror site maintained in India is expected to provide updates, on all data requirements of ADSS systems designed for energy amplification, ultimate disposal of nuclear waste by incineration and thorium utilization extending to energies up to GeV levels. The need for precise, experimental, neutron-induced and charged particle-induced nuclear data, remains indeed very strong. This would enable potential economies working for instance on new fuel designs such as using thorium and higher burn-up (few hundreds of GWD/Te) to make rapid progress. The nuclear data of isotopes of thorium fuel cycle, which have not been given enough attention in the past, has significantly improved, as a result of a recently concluded IAEA-CRP project entitled, "Evaluated nuclear data for Thorium-Uranium fuel cycle". The basic and processed nuclear data libraries are available at the website: <http://www.nds.iaea.org/Th-U/>. The experimental validation efforts in critical facilities can never exactly verify the simulated states of higher burn-up. Improved nuclear data for fission products and minor actinides are essential in developing advanced reactor

What is "nuclear data"?

Quantitative results of any scientific investigation of the nuclear properties of matter: nuclear physics data or "nuclear constants"

For example: cross sections, half-lives, decay modes and decay radiation properties, gamma rays from radionuclides.

systems, such as actinide burner systems. Nuclear data on minor actinides and fission products are also crucial in the international formulation of radioactive transport regulations. These requirements demonstrate the immediate need for experimental research, the results of which would be incorporated with the basic nuclear data. The nuclear data website in Vienna and its Mirror site in Mumbai constantly update these important basic experimental nuclear data, for the use of evaluators.

Knowledge management of nuclear data and mirror website in India

The Nuclear Data Section of the International Atomic Energy Agency (IAEA) [1] provides atomic and nuclear data worldwide. Web-based utility system for nuclear data is already well-established and gaining increased global usage. Efforts at the IAEA and other nuclear data centers [2] over the last five years, have focused on creating a multi-platform relational database and software system, that can be more easily and conveniently accessed by our users.

India offered to host the IAEA-Nuclear Data Section (NDS) Mirror Site in 1999, for the benefit of the Asian Region. The International Nuclear Data Committee (INDC) of the IAEA evaluated this proposal and recommended its implementation. Platform (operating system) independent versions of various data libraries were prepared in the NDS, over the last few years.

In India, the project for a high-speed Internet connection and a Linux-based server set-up, was founded in early 2004. Requisite software tools and data were downloaded from the IAEA site since June 2004.

The Indian nuclear data Mirror website <http://www-nds.indcentre.org.in> is now fully operational.

Fig. 1: schematically depicts the operational set-up in India.

- Under this arrangement, every 12 hours online-updating is done at the mirror with the IAEA website, through a 2Mbps internet link.
- The server is being maintained at Mumbai. The Mirror website in India that mirrors the IAEA website www-nds.iaea.org greatly helps improve services for data users, who do not have access to good internet connection, by the creation of a regional copy of the "Nuclear Data Services" website ("mirror site"). Thus for users in India, the Indian mirror site ensures fast and reliable delivery of nuclear data.

Nuclear Data Types

(Examples of data that are available at the website):

Bibliographic data

(e.g. CINDA, NSR)

Experimental data

(e.g. EXFOR)

Evaluated data

(e.g. ENDF)

Nuclear reaction data

(e.g. EXFOR, ENDF)

Nuclear structure and decay data

(e.g. ENSDF)

WIMS Library Update Project –

WIMS Libraries for thermal reactor analysis - 69/172 group from different

Evaluated Data Files

Point nuclear data compatible

with Monte Carlo codes

The nuclear data Mirror website and the associated knowledge sharing process

- Enhances development of local expertise in knowledge sharing techniques in nuclear data, such as recognition of the need for indigenous development of software, for nuclear data retrieval and processing and for inter-comparison and networking techniques. The ability to quickly and easily access nuclear data through online services in Mumbai, represents a quantum jump in our physics analyses capabilities of advanced nuclear systems and thus provides a major thrust in nuclear science and technology applications.
- Provides a center in Mumbai for education and local training. It also helps accelerate the use of better

nuclear physics data in basic research and in simulation studies. It also motivates younger colleagues to perform sensitivity studies and gain better insights into advanced reactor designs. The availability of a local Mirror site provides training in the retrieval, processing and application of nuclear data in the region. Naturally, this would also help universities in India to play a major role, in participating in Indian research activities in nuclear data evaluation, processing and integral testing, particularly for studies related to the thorium fuel cycle. Users can have full access to large nuclear databases in the Indian nuclear data mirror server, for use in human resource development and fundamental research.

- Helps us to be in touch with “technical awareness” and “international developments” in other advanced

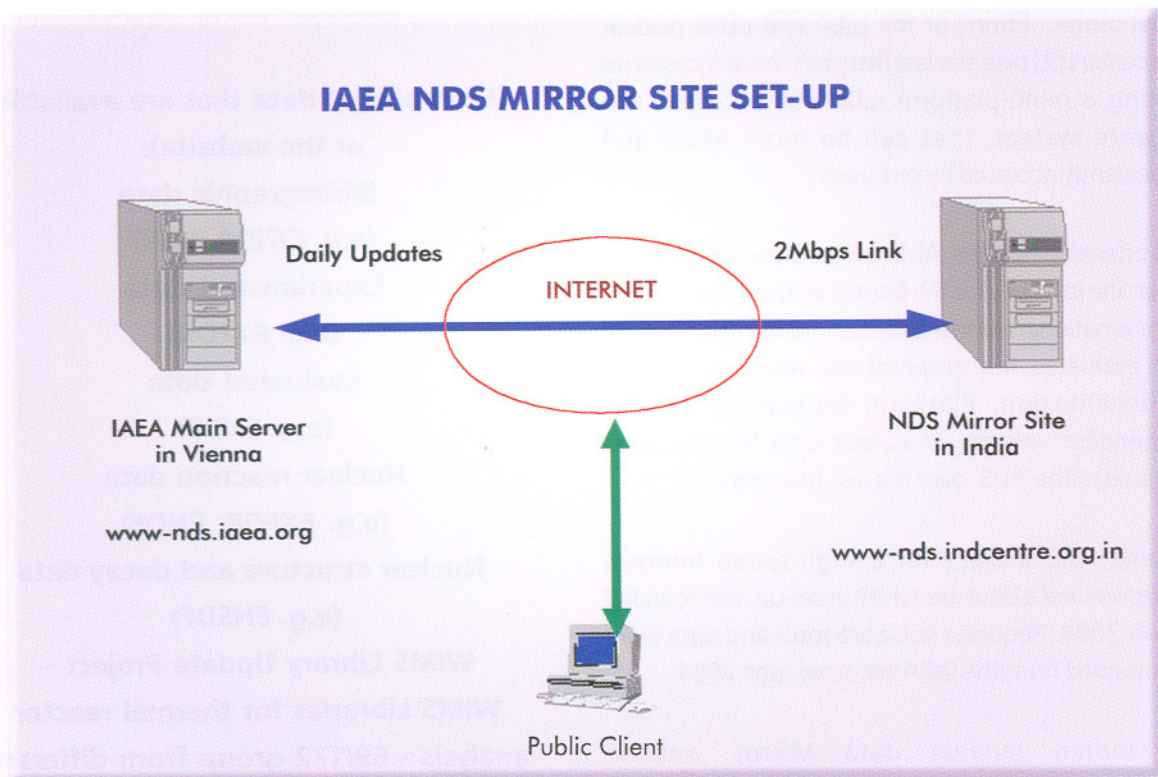

Fig. 1: The regional IAEA-NDS nuclear data mirror site in India.

countries, having a network of co-ordination centres in the field of nuclear data for various applications. The successful operation and maintenance of the Indian nuclear data mirror website, will also enable India, to offer a forum in India for inter-regional training purposes, under the auspices of the IAEA, as and when required by the Member States.

During the National Workshop [3] on "Nuclear Data for Reactor Technology and Fuel Cycle," held in Mumbai, the online nuclear services were demonstrated with illustrative examples. In the same Workshop, an IAEA representative Mr. L. Costello, also delivered a lecture on the IAEA nuclear data services and on the

Indian Mirror site.

Fig. 2 displays the home page of the Indian mirror site.

The Nuclear Data Section of the IAEA, (with one of its objectives being, to improve accessibility to nuclear data for applications), has exploited and adapted quickly, to the rapidly changing internet environment in the last fifteen years.

It may be noted that many databases like EXFOR, CINDA and ENDF/B data are also available on CDROM, free-of-cost from the IAEA Nuclear Data Section.

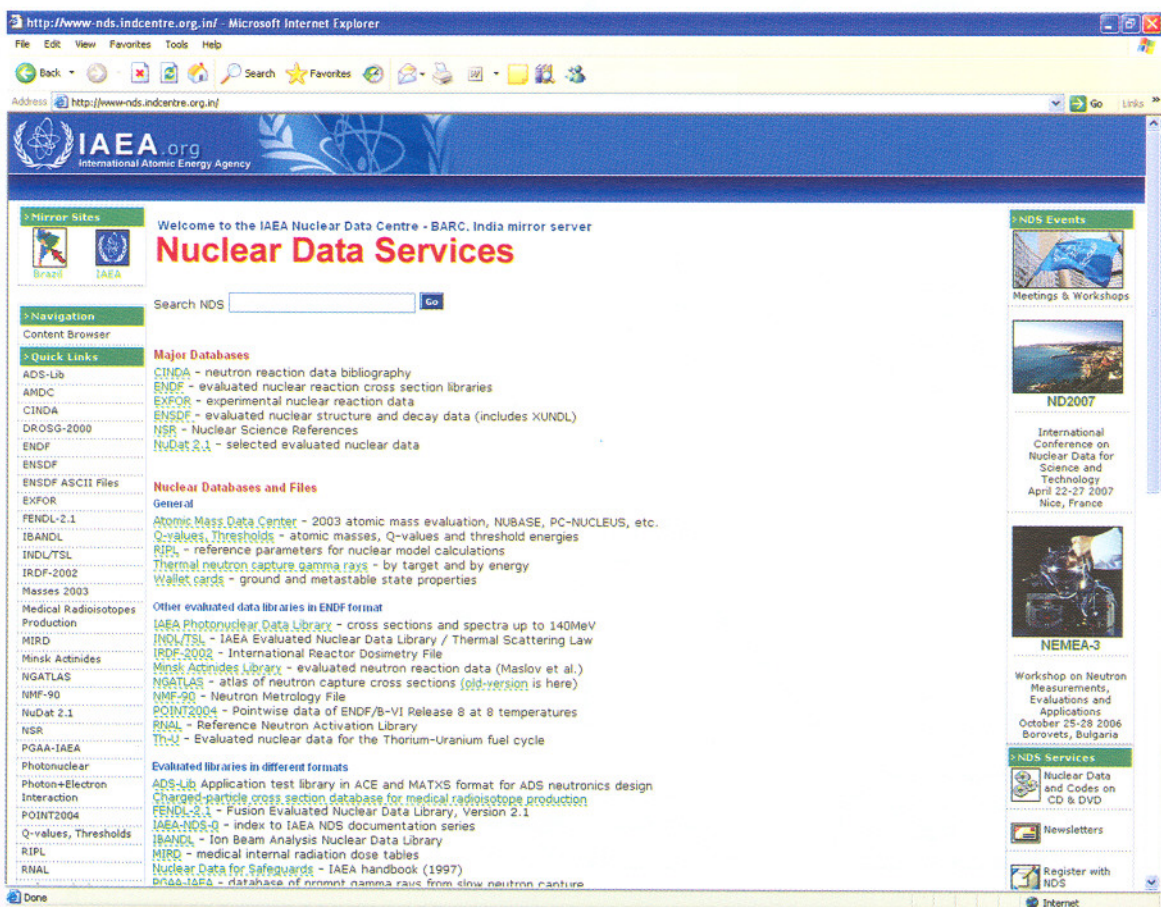

Fig. 2: Home page of the Indian Mirror site: <http://www-nds.indcentre.org.in>.

Knowledge Sharing Centres

International co-operation in the generation and sharing of knowledge on nuclear data, is the need of the hour. Users of nuclear data have long felt the need for development of core centres, in every country. A network of 13 Nuclear Reaction Data Centers and two

Mirror sites (one in Brazil and one in India) are in operation around the world.

The core centres mentioned below, provide coordinated, worldwide customer services covering the entire range of nuclear data services, as shown in Fig. 3. The vast amount of nuclear data compiled, collected

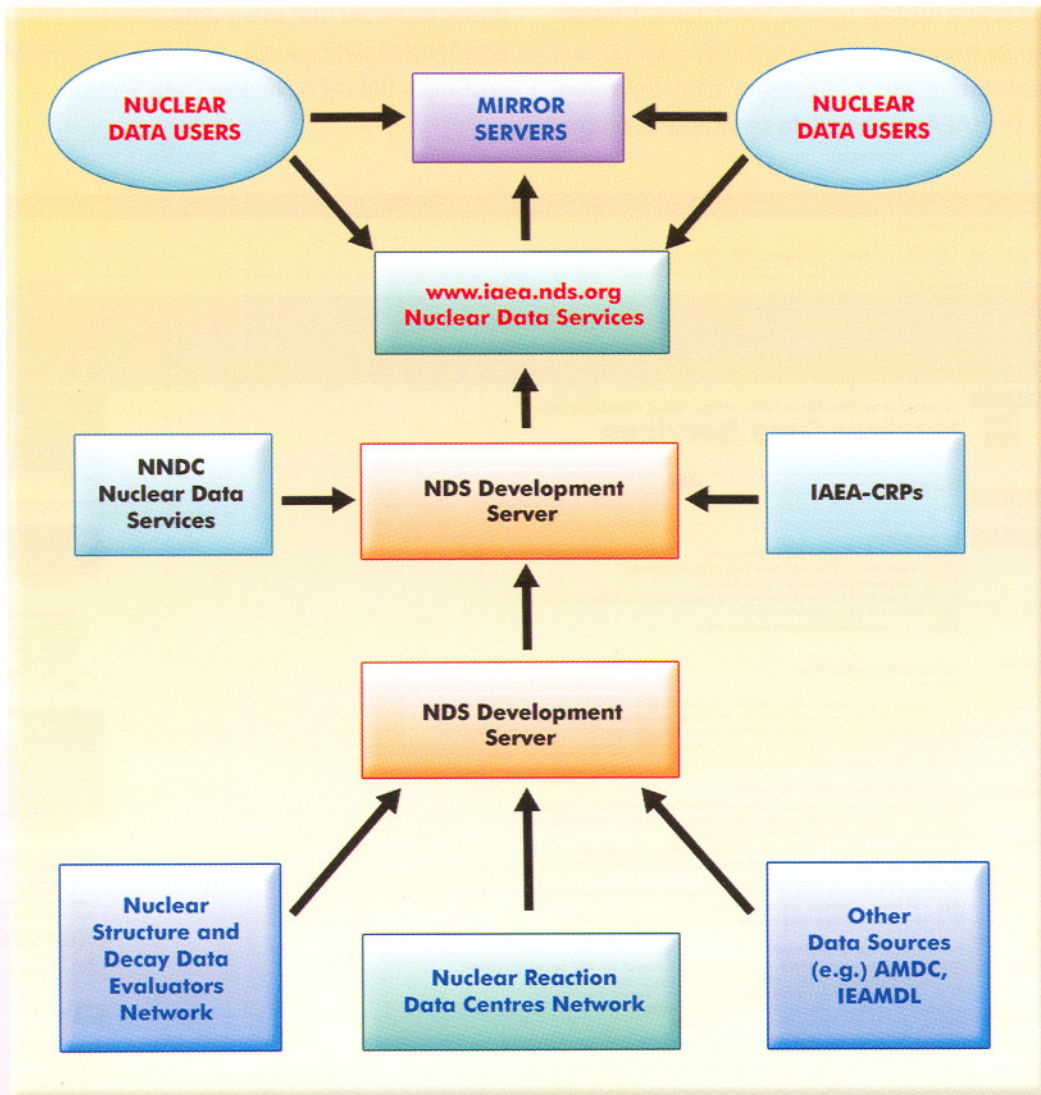

Fig. 3: Knowledge management by the IAEA-NDS.

and managed at these centres, is exchanged on a regular basis. Therefore, the knowledge base of various numerical databases, residing at these centres, is essentially identical in content (barring a small time delay). The four core centres sharing the numerical data and associated nuclear physics knowledge are:

1. The US National Nuclear Data Center (NNDC), Brookhaven National Laboratory, Upton, NY, USA meets the needs of nuclear data in the United States and Canada. <http://www.nndc.bnl.gov>
2. The OECD NEA Data Bank (NEADB), Issy-les-Moulineaux, France takes care of the requirements of nuclear data in the NEA Data Bank member countries: <http://www.nea.fr>
3. The IAEA Nuclear Data Section Vienna, Austria provides cost-free service to member countries not serviced by the other three core centers. <http://www-nds.iaea.org>
4. The Russian Nuclear Data Center (CJD), Institute of Physics and Power Engineering (IPPE), Obninsk, Russia provides nuclear data for all the countries of the former Soviet Union: <http://www.ippe.obninsk.ru/podr/cjd/>

The expanded data centre network includes additional co-operating specialized centers in Russia, China, Japan, Hungary, Korea and Ukraine. The specialized centres complement the core centres, by assuming responsibility for the collection and dissemination of data of a specialized type or application. They do not normally provide the entire range of services offered by the four core data centres. These specialised centres are:

- The Chinese Nuclear Data Centre (CNDC), China Institute of Atomic Energy, Beijing: neutron and charged particle data.
- The Nuclear Data Group, in ATOMKI Institute (ATOMKI), Debrecen, Hungary.
- The Japan Charged-Particle Nuclear Reaction Data Group (JCPRG), Hokkaido University, Kita-ku, Sapporo: charged particle interaction data.
- The Nuclear Structure and Nuclear Reaction Data Centre (CAJaD), Kurchatov Institute, Moscow: charged particle interaction data.
- The Nuclear Data Center, Japan Atomic Energy Research Institute (JAERI), Tokai-mura, Naka-gun, Ibaraki: basic evaluated data files.
- The Korea Atomic Energy Institute (KAERI), Yusong, Taejon: basic evaluated data files.
- The Centre for Experimental Photonuclear Data (CDFE), Moscow State University, Moscow: photonuclear data.
- The Nuclear Physics Data Center (NPDC), All Russian Scientific Research Institute of Experimental Physics (VNIIEF), Sarov: neutron and charged particle data.
- Ukrainian Nuclear Data Center (UkrNDC), Institute for Nuclear Research, Kyiv (Kiev): mainly for neutron data.
- Nuclear Structure Data Centers Network consists of
 - i. the IAEA Nuclear Data Section, Vienna (Co-ordination),
 - ii. the U.S. National Nuclear Data Center, Brookhaven,
 - iii. USA (Master database) and
 - iv. 13 data evaluation centers in USA, Russia, China, France, Japan, Kuwait, Belgium, Canada.
- The data centers in the IAEA, OECD-NEA, USA, France and Sweden serve as *data dissemination service providers* to their respective areas.
- IAEA Nuclear Data Mirror websites are presently operational in Brazil: <http://www-nds.ipen.br> and in India: <http://www-nds.indcentre.org.in/>

Applications of Nuclear data

Energy applications

Fission power

Fusion reactor technology

Accelerator Driven Systems

Non-energy applications

Nuclear medicine

Materials analysis and process
control safeguards

Radiation safety

Waste management

Environmental research

Basic research

(e.g. nuclear astrophysics) and
education

Cross section data and other numerical data of nuclear properties required for nuclear applications, usually evolve from a national effort, to provide state-of-the-art data that is based on established needs and uncertainties. The process requires an iterative sequence of events on a time scale of several years, to yield a quality-assured, result-oriented application library.

More detailed knowledge-sharing among these data centres can be obtained by visiting the Indian mirror site [2].

General Information on types of Nuclear Data

Nuclear data and information available on the nuclear data web server, have been created at the classical data centres, by experienced professionals.

Evaluated Data:

Data produced either through experiments or by modeling/simulation usually have ambiguities, gaps and inconsistencies. Evaluation involves mathematical and logical procedure which extracts the best out of the available data, to suit various applications. Evaluation procedure results in a consistent, complete, unambiguous, application-oriented data set the quality of which reflects state-of-the-art knowledge. Experienced nuclear theorists and researchers perform the task of evaluation to generate reliable nuclear data.

Bibliographic data: A bibliographic database to aid experimenters and evaluators is also available separately. Understanding the retrieval and usage of data, can be simple in some cases but takes considerable time and expertise in understanding different data types. These databases contain bibliographic references with some description about the contents, but no numerical data.

- Examples are CINDA (Computer Index of Neutron Data) and NSR (Nuclear Science References). The NSR database is a bibliography of nuclear physics articles, indexed according to content and spanning nearly a hundred years of research. Over 80 journals are scanned on a regular basis, for articles to be included.
- This bibliographic information comes handy in the literature survey for future experiments or for research in nuclear data evaluation.

- It should be noted that the International Nuclear Information System (INIS) that encompasses all scientific literature on the peaceful applications of nuclear science and technology, available at the URL: <http://www.iaea.org/programmes/inis/> is very useful, but is not as comprehensive a source of recommended nuclear data, as compared to IAEA-NDS.

Experimental data: These are the numerical results of individual measurements as reported by the authors. An important example is EXFOR/CSISRS, the library for experimental nuclear reaction data. EXFOR is derived from "Exchange Format" – experimental nuclear reaction data compiled regularly through the Network of Nuclear Reaction Data Centres : <http://www-nds.indcentre.org.in/exfor/>

The EXFOR library contains an extensive compilation of experimental nuclear reaction data. Neutron reactions have been compiled systematically since the discovery of the neutron, while charged particles (including reactions of interest to heavy ion fusion research and photon reactions) have been covered less extensively. The EXFOR library contains results of numerical nuclear data from more than 15,000 experiments. The users of EXFOR include data evaluators, applied users, experimentalists and theorists. EXFOR retrievals are available on the web from the sites of the major data centres and on CD-ROM.

Evaluated data libraries contain recommended data based on all available data from experiments and/or theory, collected after critical analysis of experimental data and their uncertainties, interpolation and extrapolation using nuclear model calculations.

- The data are in the internationally approved ENDF format, which can be processed with the help of pre-processing and utility codes, which are also included.
- They are stored in strictly defined formats such as ENDF-6 (the international format for evaluated nuclear reaction data) or ENSDF (the format of the Evaluated

Nuclear Structure data file. The main cross section libraries in ENDF format also contain the relevant

Network of Nuclear Reaction Data Centers and Mirror sites

Four "core centers":

- IAEA Nuclear Data Section, Vienna
- OECD NEA Data Bank, Paris, France
- U.S. National Nuclear Data Center, Brookhaven, USA
- Russia Nuclear Data Center, Obninsk, Russia

Expanded network includes additional co-operating specialized centers

in Russia, China, Japan, Hungary, Korea and Ukraine

Nuclear Structure Data Centers Network

- IAEA Nuclear Data Section, Vienna (Co-ordination)
- U.S. National Nuclear Data Center, Brookhaven, USA (Master database)
- 13 data evaluation centers in USA, Russia, China, France, Japan, Kuwait, Belgium, Canada

Data dissemination centers

- IAEA, OECD-NEA, USA, France, Sweden

IAEA Nuclear Data Mirror sites

- Brazil
- India

radioactive decay data, needed along with the main applications.

Following are the examples of the major “general purpose” evaluated nuclear data libraries containing neutron-nuclear reaction data that include cross sections, angular and energy distributions of secondary particles, resonance parameters and related quantities.

- ENDF-B/VI, Release 8 (USA),
- BROND-3 (Russia),
- JEF-3 (Europe),
- JENDL-3.3 (Japan),
- CENDL-2.2 (China)

These are available online (“ENDF” database) and on CD-ROM. It may be noted that despite five decades of nuclear data efforts, for the same physical quantity (example fission cross section of ^{239}Pu) the data from different countries do not match even today. This is due to the challenges in measurements, error assignments and evaluations. For neutron-induced reactions up to 20 MeV, the numerical information in the libraries is rather complete; the coverage for higher energies is less complete but improving. These neutron-nucleus nuclear data libraries cover the neutron energy range from 10^{-5} eV to 20 MeV, with some evaluations extending to higher energies (partly up to 1 GeV) and also including some charged-particle induced reactions. Output is available in several formats including plots and software packages (D.E. Cullen’s Pre-Processing and Utility codes) are available for resonance reconstruction, Doppler broadening, multi-grouping point data and data pre-processing treatments. Since the original evaluations use resonance parameter representation, derived point wise data by Red Cullen are also available at the Mirror site. Users can perform online comparisons of evaluated and experimental cross sections using the package ZV View developed by V. Zerkin.

Nuclear structure and decay data: The major database is ENSDF, while related bibliographic data is contained in NSR. The Evaluated Nuclear Structure Data File provides nuclear structure and decay data for all known radionuclides evaluated and compiled through Network of Nuclear Structure and Decay Data Evaluators (NSDD). The data includes

- half-lives,
- decay schemes,
- nuclear level properties,
- energies and intensities of gamma-rays and emitted particles,
- atomic masses.

The ENSDF database contains evaluated nuclear structure and decay information for over 2900 nuclides. The file is updated on a continuous basis. New evaluations are published in the journal “Nuclear Data Sheets”.

There are many other nuclear structure and decay data libraries mostly derived from or related to ENSDF; some of these are not available at the nuclear data Mirror site or the IAEA-NDS. Those that are not available at the mirror site or the IAEA server include the *Table of Isotopes*, the *Isotope Explorer*, a computer program for viewing ENSDF and for interactive access to nuclear structure and decay data and *NUBASE*, a library of nuclear and decay properties.

Additional Databases

More than a hundred numerical nuclear data libraries are available free of cost on the internet, on CD-ROMs and other media for fission and fusion energy and non-energy applications and basic nuclear physics research. There are several other databases [4], which are mentioned briefly here.

The Nuclear Wallet Cards: The Nuclear Wallet cards that provide basic properties of ground and metastable states are most widely accessed at the mirror site. This knowledge database is also available as a pocket booklet (from US-NNDC; T. K. Tuli (ed.), *Nuclear Wallet Cards*, Sixth edition, January 2000 (National Nuclear Data Center, Brookhaven, USA). Nuclear wallet cards also deal with data for issues identified with US Homeland Security: <http://www.nds.indcentre.org.in/wallet/index.html>

RNAL: Reference Nuclear Activation Library of 255 neutron-induced reactions for activation analysis. -<http://www-nds.indcentre.org.in/ndspub/rnal/www/>

FENDL-2.1: updated cross-section library tailored for fusion applications: <http://www.nds.indcentre.org.in/fendl21/>

RIPL: Reference Input Parameter Libraries for nuclear model calculations of nuclear reactions: <http://www-nds.iaea.org/ripl/> and <http://www-nds.iaea.org/RIPL-2/>

MIRD: Medical Internal Radiation Dose, based on ENSDF and data processed by RADLST (tables of energies and intensities of emitted radiations): <http://www-nds.iaea.org/mird/>

XG Standards: X-ray and γ -ray decay data standards for detector efficiency calibration (decay data of selected radionuclides)

ADS-LIB/V1.0: A test library for Accelerator Driven Systems <http://www-nds.indcentre.org.in/ads/>.

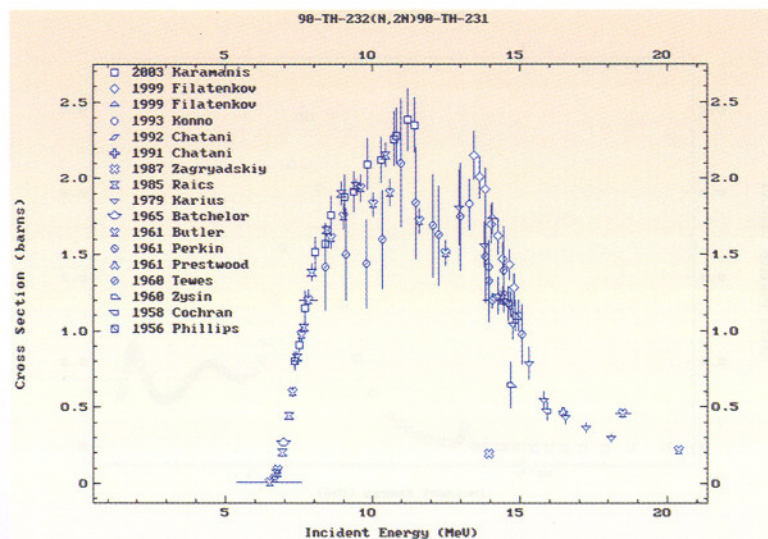

Fig. 4: The cross section data for the nuclear reaction $^{232}\text{Th}(n, 2n) ^{231}\text{Th}$. This reaction, though, occurs above 6.3MeV, plays an important role in thorium cycle, even in thermal reactors, where the fractional flux above 6MeV is just about 0.05%. It also provides proliferation resistance by leading to the formation of ^{232}U .

Sample illustrations of basic data using the Indian nuclear mirror website

In this section, we will demonstrate a few exercises as examples of nuclear data retrieval. These examples strikingly illustrate the importance of accurate knowledge base in applications.

Fig. 4 depicts an interesting example of data retrieval from the Indian Mirror nuclear data website. The “raw” experimental cross section data for the nuclear reaction $^{232}\text{Th}(n, 2n) ^{231}\text{Th}$ that plays a dominant role in the formation of ^{232}U in thorium fuel bundle irradiated in Indian Pressurized Heavy Water Reactors for power flattening is depicted.

Fig. 5 provides an example of data, retrieved from the EXFOR database for neutron-free nuclear energy involving a proton hitting ^{11}B nucleus towards neutron-free (aneutronic)

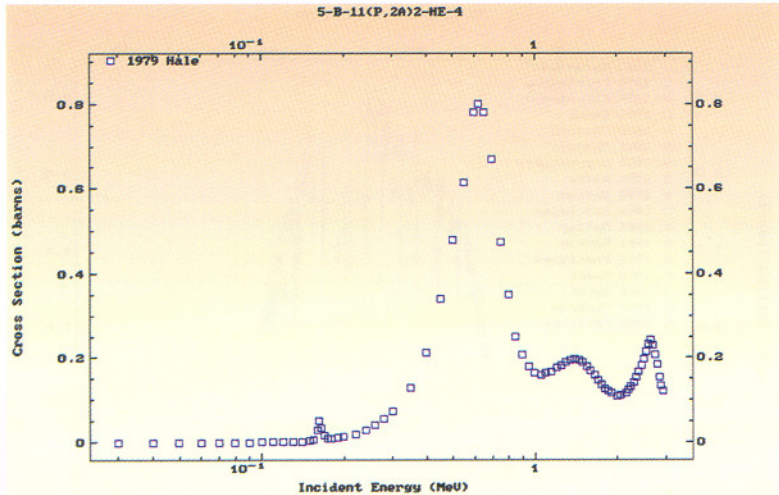

Fig. 5: An example of retrieval of cross section for neutron free nuclear reaction: Proton hitting a target of ^{11}B isotope leading to the release of three helium nuclei. (W, Hale, EXFOR entry no. 790207, 1979, Report: Los Alamos Scientific Lab.No.7066, PR, p.2). The useful data for research towards developing clean nuclear energy systems, involving zero radioactive waste, was readily obtained by performing an EXFOR query, in the Indian nuclear data mirror server.

beta decays (with a half-life of 806.7 ± 1.5 milliseconds) to ^6Li which is a known neutron poison with a high neutron absorption cross-section. The build up of ^6Li at burn-ups envisaged for the Energy Amplifier (150GWD/Te) has resulted in a significant burn up swing penalty in Accelerator Driven Sub-critical Systems (ADSS). Therefore, the use of Be was dismissed as a possible coolant in ADSS.

The improved knowledge base of nuclear data helps significantly reduce the number of costly experiments for code and data validations in various nuclear applications. Data users demand provision of huge quantity of databases with high degrees of quality, credibility and validity.

nuclear reaction: Boron-11 + proton \rightarrow three alpha particles, as discussed by Carlo Rubbia [7].

Another interesting example of the use of EXFOR data is depicted in Fig. 6. A plot of raw experimental data of $^9\text{Be}(n, \alpha)^6\text{He}$ reaction, retrieved from the Mirror site is shown. This nuclear reaction has received some attention, in the Energy Amplifier concept, in comparing Be versus Pb as a coolant. It has a threshold of 0.6 MeV. The cross section rises to a peak value of 110 millibarns at about 3 MeV. Investigations have shown that the advantages of the neutron multiplying Be (n, 2n) reaction are offset by $^9\text{Be}(n, \alpha)$ reaction that produces ^6He which

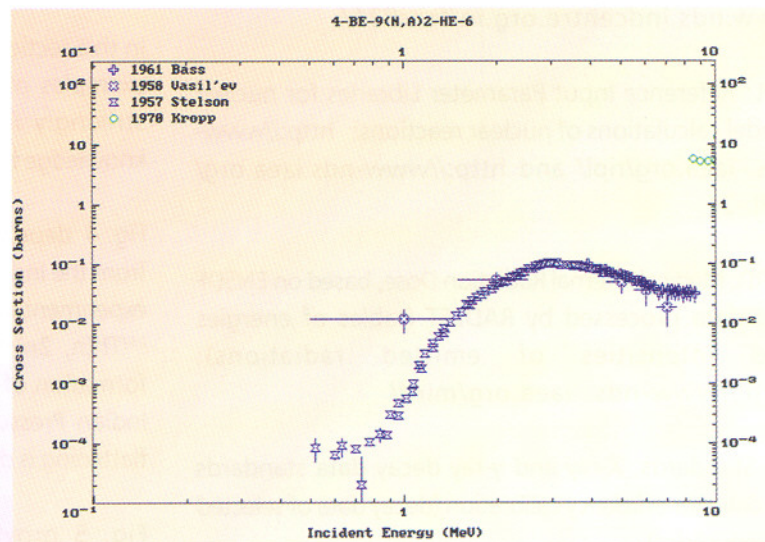

Fig. 6: A plot of "raw" experimental data of $^9\text{Be}(n, \alpha)^6\text{He}$ reaction retrieved from the Mirror website.

Rapid access and availability through international and national data centres is automatically expected by front-line researchers and application programmes.

Concluding remarks

India now sponsors a regional IAEA-NDS nuclear data Mirror Site (<http://www-nds.indcentre.org.in>) for the Asian region. The use of this regional website on nuclear data is increasing.

In this article, an attempt has been made to present a brief introduction to the Indian nuclear data mirror site. The knowledge-sharing techniques, developed by the nuclear data centres around the world, have been largely very successful in meeting the needs of nuclear data. Indian nuclear data activities have generically encompassed the user-oriented approach starting from basic evaluated nuclear data files distributed by the IAEA and making use of published experimental benchmarks. Knowledge management and critical evaluation of basic nuclear data and associated uncertainties should be rigorously sustained, well supported and further pursued. India has initiated a number of indigenous activities on basic neutron data measurements using its own advanced facilities, nuclear model based predictions and evaluations of basic nuclear data. India also pursues integral validation of codes and nuclear data using Advanced Heavy Water Reactor Critical facility, which is under development.

References

1. <http://www-nds.indcentre.org.in>
2. <http://www-nds.indcentre.org.in/nrdc.html>
3. S. Ganesan et al., (Ed.) Abstract booklet and CDROM Proceedings of the National Workshop on Nuclear Data for Reactor Technology and Fuel Cycle, March 7-10, 2005, Bhabha Atomic Research Centre, Mumbai.
4. Alan L. Nichols, Liam Costello, Viktor V. Zerkin, "Nuclear Data Services of the International Atomic Energy Agency: An Overview," CDROM, Proceedings of the National Workshop on Nuclear Data for Reactor Technology and Fuel Cycle, March 7-10, 2005, Bhabha Atomic Research Centre, Mumbai.
5. S. Ganesan, "New reactor concepts and new nuclear data needed to develop them," Invited Talk, pp. 1411-1416, International Conference on Nuclear Data for Science and Technology, ND2004, American Institute of Physics (AIP) Conference Proceedings CP 769, May 2005.
6. www.dae.gov.in and www.barc.gov.in
7. Carlo Rubbia (ENEA, Italy), "The role of Research for a sustainable development of Nuclear Energy," Talk delivered at the IAEA on 21 September 2004.
8. S. Ganesan, "Nuclear Data Needed to Develop Advanced Nuclear Systems," pp. 9-17, Proceedings, Invited Talks, Sixteenth Annual Conference of Indian Nuclear Society (INSAC-2005), S. Ganesan et al., (Eds.). November 15-18, 2005, Mumbai.

DEVELOPMENT OF AN ELLIPTICAL CRYSTAL BENDER

The Centre for Design and Manufacture (CDM), BARC has developed a crystal bender, which can be used to produce elliptically shaped crystals for use in EXAFS beamline at INDUS-II synchrotron radiation source. Function of this crystal bender is to generate an elliptical shape of a particular portion of an ellipse, by bending a 460 mm long flat Si (111) single crystal.

This development work is of great importance because, generating highly accurate elliptical surfaces by conventional grinding and polishing methods or by any

other method with optical accuracy is very difficult, whereas production of flat surfaces to the required tolerance is comparatively easy.

The basic idea to use a silicon single crystal, bent in the shape of an ellipse in a particular fashion, is to define the position of radiation source and sample (Fig. 1). These positions are at the two foci of the ellipse. Synchrotron radiation emitted from the source (1st focus of ellipse) will fall on the bent crystal, which disperses the beam according to its energy. Bent crystal

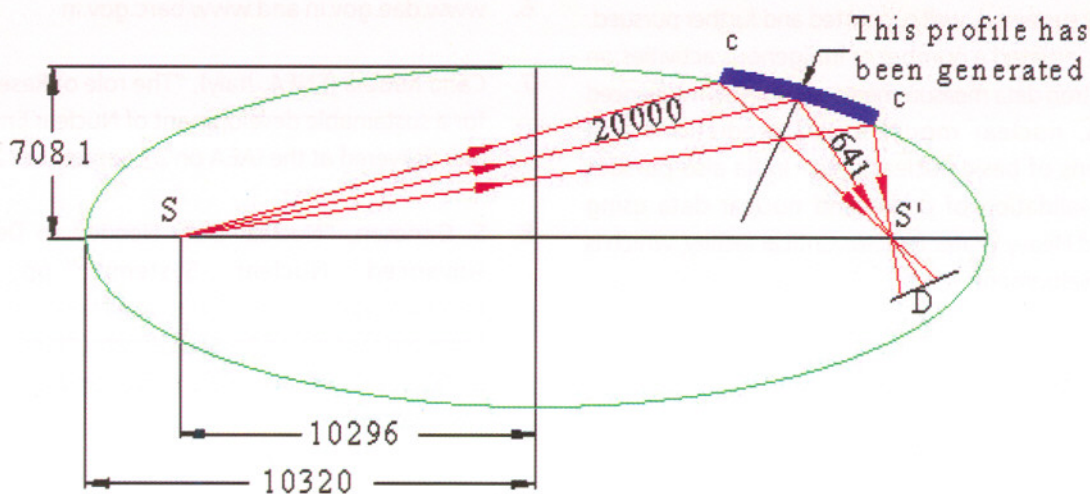

Fig.1: Schematic showing silicon flat plate 'cc' after it is bent by bender
S=Source Position , S'=Sample Position, D=Detector Position

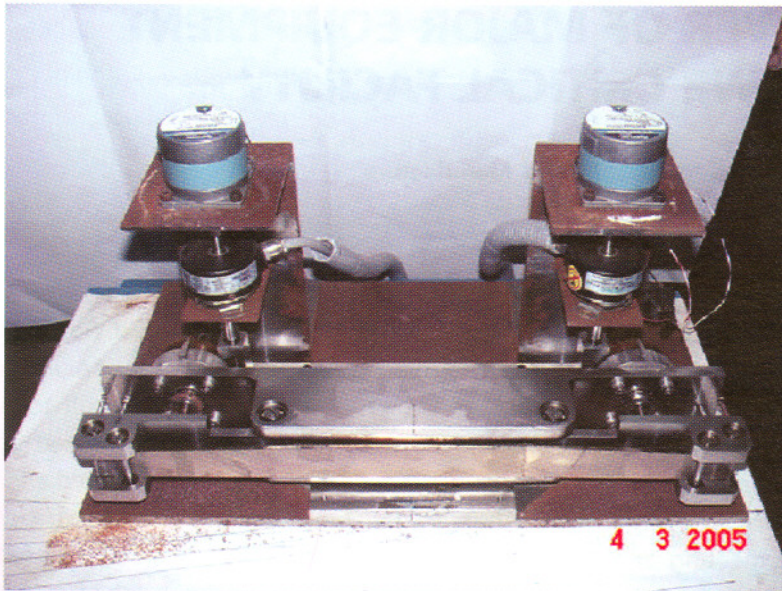

Fig. 2: Elliptical bender without cooling arrangement

acts as a polychromator and also as a focusing element. The dispersed radiation of particular energy will be focused at the sample positioned at another focus of the ellipse. As per the optical design, shape of the required silicon single crystal has to match to a particular sector of an ellipse of major axis 20640 mm and minor axis 1416.2 mm for precise focusing of the beam falling on the bent crystal for 10 keV photon energy.

In the present design provision has been made to change the major axis and minor axis to cover the broad band of energy varying from 5 keV to 20 keV, by controlled and pre-decided motorized rotations of the ends of the crystal plate (Fig.2). The bender shown in Fig.2 is without cooling arrangement and is

not Ultra High Voltage (U.H.V.) compatible. The bender shown in Fig.3 is U.H.V. compatible and cooling arrangements for crystal have also been provided. Before sending it to INDUS-II, Raja Ramanna Centre for Advanced Technology (RRCAT) Indore, the same has been tested optically by the Spectroscopy Division and CDM. Minimum width of focus line, which was obtained by this bender was 300 microns and which was acceptable to the user.

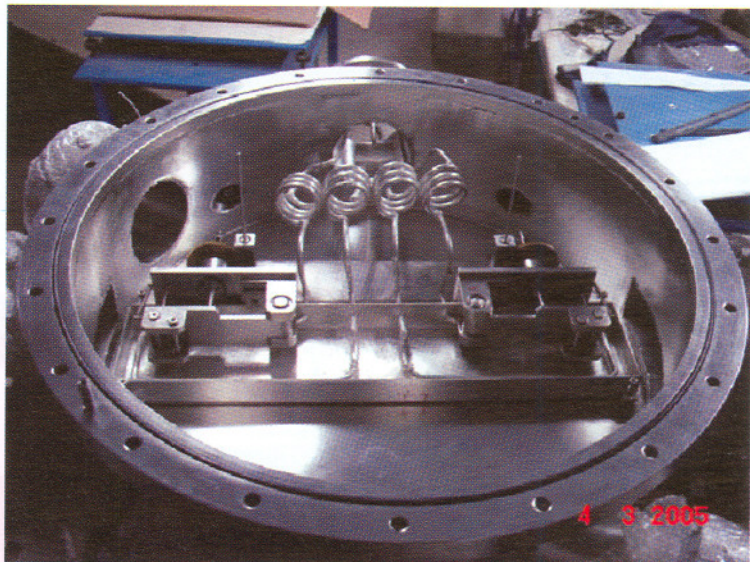

Fig. 3: Elliptical bender with cooling arrangement inside a vacuum chamber

HANDING OVER OF MAJOR EQUIPMENT FOR AHWR CRITICAL FACILITY

by
Centre for Design and Manufacture

A technical briefing was held on January 30, 2006 at the Centre for Design and Manufacture (CDM), BARC, at the time of handing over of three major equipment manufactured by CDM for AHWR Critical Facility to the user. Director, BARC, Director, Automation & Manufacturing and Electronics & Instrumentation Groups, Director, Reactor Group, Associate Director, Reactor Group were present at the meeting and addressed the audience.

On this occasion the three equipment which were handed over were – (1) Reactor Tank, (2) Square Box and (3) Reactor Tank Support.

Reactor Tank is an important reactor vessel of 3.3m diameter, 10mm wall thickness and 5m height. (Figs.1 & 2). It is made of 1060-1S grade of Aluminium. As is well known, Aluminium is a difficult to weld material. The welders who previously welded Spare Calandria shell for CIRUS Reactor had retired and the new batch of welders were finding it difficult in obtaining good quality welds. A need was felt to arrange special training for the new batch of welders at the works of expert fabricators of large Aluminium equipment. After such training, the quality of Aluminium welds improved. The welders could also learn and implement successfully, the "Twin Welder"

welding technique, where two welders weld the Aluminium plate simultaneously from the opposite sides of the plate in perfect synchronization. The job needs to be pre-heated to a temperature of about 200°C and it makes continuous presence of the welder near the job somewhat uncomfortable, when welding in horizontal, electrode down (1G) position. Twin welder technique, with job kept vertical, reduced this uncomfortable problem. Additionally, to reduce porosity problems in welds, high purity Argon gas was used, where impurity level in the gas is less than 5 ppm. A cent percent radiography



Dr S. Banerjee, Director, BARC, addressing the meeting



Fig. 1: Reactor Tank under fabrication

quality joints of a total length of 50m was successfully completed, with minimum repairs and minimum welding distortion. Bottom plate of the tank is 40mm thick and it was machined only at the intermediate stage of manufacture and yet flatness and parallelism of unmachined, open, top end face of 5m Reactor Tank was maintained within 3mm with reference to the bottom machined plate. This was an achievement for CDM, as there was no provision for machining of the angle ring on the open end of the Tank. The Tank subsequently conformed to all the pressure and leak test requirements, like pneumatic and hydro-pneumatic leak tests. At one stage, it was essential to fill the Tank with 22 tons of water for these tests. The tank was thoroughly cleaned as per procedure approved by the User and the Reactor Tank has been shifted to the Critical Facility building.

The second major equipment is the Square Box assembly for the Critical Facility (Fig. 3). It consists of about

300 manufactured components. The Square Box would be sitting on top of the Reactor Tank at the site. The Square Box assembly is a 4.6m long x 4.6m wide x 1.5m high hollow, closed square box made of Stainless Steel plates and angles. It contains nine movable girder sub-assemblies, which will hold the lattice tubes of the reactor core. It has a revolving plate at its top end, in which, suitable openings are provided for accessing any specific lattice position of the reactor core. Precision machining of 2.8m diameter bearing, for the revolving plate assembly is a noteworthy achievement. The Square Box also is pneumatically leak tested, cleaned, passivated and is ready to be shifted to

site, as soon as the Reactor Tank is shifted and installed in position.

The third equipment, the Reactor Tank Support is about 3.7m in diameter and 800mm thick assembly of specially fabricated Aluminium I-beams, made by welding corresponding thickness plates (Fig. 4).



Fig. 2: Handling of Reactor Tank



Fig. 3: Fabricated square box

For ease of manufacture, a change of weldment for these 800mm high Aluminium I-Beams was suggested. A mock-up I-Beam, with weldments was manufactured and tested its load carrying capacity was tested at MSD Mechanical Testing Facility. The results were satisfactory and convincing enabling it, acceptance by the user. Thus, the large size I-beams, involving about 120m of 12mm size fillet welds were successfully completed with minimum difficulty and repairs and with zero rejection rate. The Reactor Tank Support has already been delivered and satisfactorily installed at the site by the User.

Manufacturing cost for all this equipment, if outsourced, would be about Rs. 2.8 crores.



Fig. 4 : Support structure

ANNOUNCEMENT

Forthcoming conference PBAMP 2006

The DAE-BRNS symposium on "Power Beam for Clean Environment and Processes" will be held during September 20-21, 2006 at the Multipurpose Hall of BARC Training School Hostel, Anushaktinagar, Mumbai.

The theme of the symposium would be the application of power beams namely plasma, laser and electron beams, for creating a clean, pollution-free environment, using new enabling technologies. Other areas to be covered include: Fundamentals of beam processing, modeling and diagnostics, treatment/beneficiation of industrial, bio-medical and municipal waste, radioactive waste treatment and other new research areas.

Important Dates

- | | |
|---------------|---|
| June 15, 2006 | : Submission of pre-registration forms |
| July 15, 2006 | : Manuscript for participant presentation |

For further details, contact :

Dr. N.K. Joshi

Convener, PBAMP-2006

Laser and Plasma Technology Division

Bhabha Atomic Research Centre

Trombay, Mumbai 400085, India

Tel: +91-22-25590512

Fax: +91-22-25505151

Email: nkjoshi@barc.gov.in

Homepage : <http://www.powerbeam.org>

BARC TRANSFERS TECHNOLOGIES FOR "TLD PHOSPHOR AND TLD BADGE"

Technologies for "Thermoluminescence Dosimeter (TLD) Phosphor and TLD Badge" developed by the Chemistry Division and the Radiological Physics & Advisory Division (RP&AD) respectively, have been transferred to M/s. Avantttec Medical Systems (P) Ltd., Chennai.

Thermoluminescence Dosimeter (TLD) Phosphor:

Among thermoluminescence phosphors, dysprosium doped calcium sulphate ($\text{CaSO}_4:\text{Dy}$) phosphor, is one of the most efficient phosphors, for use in radiation dosimetry, i.e. for monitoring the radiation (Gamma or X-ray) dose, received by personnel working with radiation. Briefly, the process consists in

dissolving requisite amounts of both high purity calcium sulphate and dysprosium oxide (Dy_2O_3) in concentrated Sulphuric acid (H_2SO_4) and then crystallising out the product, by distilling off the H_2SO_4 , under reduced pressure. The crystallised product is annealed at a desired temperature or quenched, to achieve the high sensitivity of the phosphor powder. This phosphor powder is the raw material for making TLD badges.

Thermoluminescence Dosimeter (TLD) Badge:

Personnel radiation doses received by radiation workers, are determined from measurements made on a device called TLD Badge, carried by the personnel.



Photograph after signing technology transfer agreements, from right to left are:
Dr R.K. Kher, Head, C&DRS, RP&AD, Mr K.B. Bhat, CD, Dr V.K. Jain, Head, S&PMS, CD, Mr B.P. George, Director, M/s Avantttec Medical System (P) Ltd., Chennai, Dr R.B. Grover, Director, KMG, Mr A.M. Patankar, Head, TT&CD, Mr B.K. Pathak, Head, TTS, TT&CD, Ms Soniya S. Murudkar, TT&CD.

This is called Personnel Radiation Monitoring. Thermo Luminescence Dosimeter (TLD) badge is a device, worn on the chest by the radiation worker, for monitoring the ionizing radiation that he is exposed to. It is based on the phenomenon of thermo-luminescence i.e. emission of light from certain materials, when heated after being exposed to radiation. The emitted light intensity is measured with Photo Multiplier Tube. Measurement of the proportion between radiation exposure and thermoluminescence, yields radiation dose measurements. The raw material of the badge is dysprosium doped CaSO_4 -TLD phosphor. This phosphor is blended with Teflon powder, for making TLD disc dosimeter. TLD badge consists of three disc-dosimeters, that are clipped on to the holes, made on a metallic card, which in turn is housed in a plastic cassette. The first disc has Al and Cu combination filter, the second disc has a plastic filter and the third disc has no filter. The metal filters on the first disc, cut-off the beta radiation and the disc gives Thermo Luminescence (TL) due to X-ray and gamma radiation. The plastic filter on the second disc, cuts off soft-beta radiation and records X-ray, gamma and hard beta radiation, whereas the third disc (with no filter), records all the radiation. Algorithms involving these filter combinations of 3 disc-dosimeters, help in identification of the types of radiation (X, gamma and beta) to which the badge is exposed and the estimation of whole body and skin dose. The TLD Badge is used by occupational radiation workers in the nuclear fuel cycle, medical, industrial and research applications of radiation. It can measure doses ranging from $100 \mu\text{Sv}$ to 10 Sv.

The Technology Transfer & Collaboration Division, BARC managed all activities related to the transfer of these technologies. It involved evaluation of the technology, documentation of the technology, estimation of technology transfer fee to be charged, announcement of the technology, evaluation and selection of a capable transferee, preparation and signing of the technology transfer agreement.

ANNOUNCEMENT

International Conferences on Advances in Materials (ANM-2006)

December 12-14, 2006
and

Materials Behaviour under Conditions Far from Equilibrium (MBNEC-2006)

December 15-16, 2006

Venue :
Central Complex Auditorium,
Bhabha Atomic Research Centre,
Mumbai 400085, India

Sponsored by
Board of Research in Nuclear Sciences, DAE &
Indian Institute of Metals (Mumbai Chapter)

ANM-2006 would broadly cover: Fuel materials for thermal and fast reactors; structural materials for thermal, fast and fusion reactor materials and materials for energy conversion & storage.

MBNEC-2006 would focus on latest research on materials behaviour under conditions far from equilibrium. The processes Rapid solidification, shock pressure, radiation damage, Ion Implantation, severe deformation, nanostructures, processing in low gravity, etc. leading to non-equilibrium conditions would be covered.

Submission of Abstracts : 30th June, 2006
Acceptance of abstracts : 31st July, 2006
Submission of full paper : 15th October, 2006

Address for further details :

Mr. R.P. Singh

Convener, ANM-2006 and MBNEC-2006
Head, Atomic Fuels Division,
BARC, Trombay, Mumbai 400085, India
Tel: +91-22-25505186 Fax: +91-22-25519613
Email: rishi@barc.gov.in
Website : <http://www.barc.gov.in/symposium/anm06>

WORKSHOP ON THERMAL ANALYSIS TECHNIQUES: A REPORT

A two-day National workshop on "Recent Developments in the Applications of Thermal Analysis Techniques in Nuclear and other areas of Research", was held during 15-16 December 2005 at the School of Studies in Chemistry, Jiwaji University, Gwalior, India. The workshop was sponsored by the Board of Research in Nuclear Sciences (BRNS), Department of Atomic Energy and jointly organised by the Indian Thermal

Analysis Society (ITAS) and Jiwaji University, Gwalior. The workshop was convened by Prof. Rajeev Jain, Head, Department of Chemistry, Jiwaji University. Dr (Ms) Radha Tomar, Reader in Chemistry, was the Organising Secretary.

The workshop was inaugurated by Dr V. Venugopal, Director, Radiochemistry and Isotope Group, BARC and



At the inaugural function, from left to right are:
Dr V. Venugopal, Director, Radiochemistry and Isotope Group, BARC & President, ITAS,
Colonel Raghbir Singh, Prof. (Ms) Kirti Saxena, Additional Director, Higher Education,
Gwalior and Dr D.S. Chandel, Registrar, Jiwaji University



Group photograph of resource persons with participants at the function

President, ITAS. The function was presided over by Prof. D.C. Tiwari, Vice-Chancellor, Jiwaji University. Several dignitaries: Colonel Raghbir Singh, Prof. (Ms) Kirti Saxena, Additional Director, Higher Education, Gwalior and Dr D.S. Chandel, Registrar, Jiwaji University graced the occasion.

The academic sessions included lectures from Dr S.R. Dharwadkar, Dr D. Das, Dr P.V. Ravindran, Dr T.R.G. Kutty, Dr (Ms) S.R. Bharadwaj, Dr S.K. Sali from BARC, Dr Arun Pratap, M.S. University and Mr G. Padmanabhan, NETZSCH India Ltd., Chennai.

The workshop also included some demonstration experiments and practicals, which were conducted at the Defence Research & Development Establishment (DRDE), Gwalior. The participants were introduced to techniques such as TG/DTA, TMA, SEM etc. The workshop was attended by about 60 participants consisting of post-graduate students, research scholars and university lecturers.

15TH DAE-BRNS NATIONAL SYMPOSIUM AND WORKSHOP ON 'THERMAL ANALYSIS'

The 15th DAE-BRNS National Symposium and Workshop on 'Thermal Analysis' was held at the University of Rajasthan during February 6-10, 2006. The Symposium was inaugurated by Dr V. Venugopal, Director, Radiochemistry & Isotope Group, BARC in a function presided over by Dr N.K. Jain, Vice-Chancellor, University of Rajasthan, in the Humanities Hall of the university campus.

In his inaugural speech, Dr Venugopal dwelt upon the relevance of Thermal Analysis in the field of Nuclear Technology, Nanomaterials, Polymers, Catalysts and Pharmaceuticals apart from its applications in ceramics and glasses. He cited the active role played by thermal methods in the development of the unique mixed-carbide fuels, which have surpassed all calculations in their performance in the Fast Breeder Reactor at



At the inaugural function from left to right are: Dr (Ms) Kananbala Sharma, Secretary, Local Organising Committee. Mr S.C. Parida, Secretary, National Organising Committee, Mr B.K. Sharma, Dean, Faculty of Science, University of Rajasthan, Dr V. Venugopal, Director, Radiochemistry & Isotope Group, BARC, Dr N.K. Jain, Vice-Chancellor, University of Rajasthan, Dr B.K. Srivastava, Head, Department of Physics, University of Rajasthan, Dr G.A. Rama Rao, Convener of the Symposium, and Prof. N.S. Saxena, Convener, Local Organising Committee.

Kalpakkam. He encouraged younger student participants from the universities to prepare themselves for challenging opportunities in nuclear technology and said that this symposium would provide them with an opportunity to interact with experts.

Dr Jain, in his presidential address, thanked DAE for choosing the University of Rajasthan to hold the symposium on thermal analysis and expected that this would pave the way to cementing a strong bond between DAE and the University for collaborative projects. He enumerated the growth of the university over the years and the creation of several faculties.

More than 150 delegates from various universities and institutes participated in the symposium and workshop. The proceedings of the symposium were released by Dr Venugopal for distribution to the delegates. The workshop volume containing lectures from experts was released by Dr Jain on this occasion. There were 10 technical sessions and 10 invited lectures. A total of 124 research papers were presented in the symposium both orally and through poster. Out of the 124 papers, 69 papers were contributed by participants from non-DAE institutions. An invited talk on the application of thermal analysis in Pharmaceuticals was the highlight of the symposium, as there were not many papers presented on the topic.

Prof. N.S. Saxena, Convener, Local Organising Committee, welcomed the participants and Dr B.K. Srivastava, Head, Department of Physics, highlighted the activities of the Department, in the field of Thermal Analysis. Dr B.K. Sharma, Dean, Faculty of Science explained different aspects of Thermal Analysis pursued

at various departments, the infrastructure that was developed by various departments through indigenous approach and the several projects from BRNS, UGC and CSIR, handled by the university. Dr G..A. Rama Rao, Convener of the Symposium highlighted the salient features of the symposium and the innovative changes that were incorporated during this symposium. Mr S.C. Parida, Secretary, National Organising Committee, announced the awards instituted by Indian Thermal Analysis Society (ITAS). The awards were presented by Dr Venugopal and Dr Jain. The inaugural programme concluded with formal thanks from Dr (Ms) Kananbala Sharma, Secretary, Local Organising Committee.

The local newspapers gave wide coverage to the symposium and also published the highlights of the lectures delivered at the symposium.

ITAS awarded cash and merit certificates in both oral and poster sessions. It also awarded the best paper presentation in both the groups to encourage young researchers in the field of thermal analysis.

The workshop following the symposium was attended by 71 participants. Nine lectures were delivered in the workshop spanning two days. The lectures essentially covered the basics of various techniques and methodologies for several applications. The participants interacted freely with the speakers. A demonstration experiment was arranged for the participants on the measurement of the thermal diffusivity in solids, by employing indigenously fabricated equipment, in the Department of Physics, University of Rajasthan.

DAE-BRNS SOLID STATE PHYSICS SYMPOSIUM (GOLDEN JUBILEE EVENT: DECEMBER 5 – 9, 2005)

The Golden Jubilee of the Annual Solid State Physics Symposium, sponsored by the Board of Research in Nuclear Sciences (BRNS), was organized during Dec. 5-9, 2005. Over the years, this symposium has evolved into a platform for young researchers to come together and share their recent work with senior scientists, both from India and abroad and benefit from the interaction. The symposium covered a wide range of subject categories pertaining to condensed matter Physics. Though the main venue for the 50th DAE-BRNS Solid State Physics Symposium was the Central Complex auditorium of BARC, all the sessions on Dec. 7 were conducted at the Tata Institute of Fundamental Research (TIFR), the other premier DAE Physics laboratory in Mumbai.

To ensure that the Golden Jubilee event became a truly memorable one for both the delegates and the participants, three committees were constituted: (a) the Apex Advisory Committee with Dr P.K. Iyengar (Former Chairman, AEC) as the Chairman; (b) a National Organizing Committee with Dr V.C. Sahni, Director RRCAT, Indore and Director, Physics Group, BARC as the Chairman; and (c) an Implementation Committee of the Symposium with Dr J.V. Yakhmi, Associate Director (S) Physics Group, BARC, as Convener. As per convention, two secretaries, Dr V.K. Aswal, SSPD (BARC) and Dr K.G. Bhushan, TPPED (BARC), were appointed to coordinate the academic activities of the symposium. A Local Organizing Committee was constituted with Dr G.P. Kothiyal, TPPED, as the Local Convener. Several sub-committees were constituted to ensure organised conduct of the event. Being the Golden Jubilee event, a large participation was expected and the response was overwhelming. Over 750 contributed papers were

received from various research institutes and universities across the country. To conduct the Symposium smoothly, without dampening the enthusiasm of the researchers, it was decided to accept 540 papers in all, the limitation arising mainly due to logistic reasons, particularly to provide accommodation to outstation participants.

A novel refereeing procedure was adopted, in view of the large number of contributed papers. Separate co-ordinators were nominated for each of the 12 subject categories. These Co-ordinators got the papers reviewed by at least two referees, largely through e-mails. The subject categories covered were:

- (A) Phase Transitions
- (B) Soft Condensed Matter including Biological Systems and Liquid Crystals
- (C) Nano-materials
- (D) Experimental Techniques, Instrumentation and Solid State Devices
- (E) Liquid, Glasses and Amorphous Systems
- (F) Surfaces, Interfaces and Thin Films
- (G) Electronic Structure and Phonons
- (H) Superconductivity
- (I) Transport Properties
- (J) Semiconductor Physics
- (K) Magnetism including Spintronics
- (L) Novel Materials including Single Crystals

In addition to this, a special refereeing group (the 'Z' category) was formed, comprising senior scientists, who were independently given the charge of refereeing all the papers, under a given category, pertaining to their specialisation. Unlike previous years, when each

contributed paper was refereed either as accepted or rejected, a rating of 1 to 10 was given for each of the refereed paper this year. It was thus ensured, that each paper was refereed at by least three different referees and the average of their ratings was taken as the criterion for acceptance. Papers with getting a rating below 6, were generally rejected. In some categories, where the average ratings were consistently high, the cut-off rating was adjusted to be higher than .5 thus ensuring a uniform rate of acceptance, in all the 12 categories. The final rejection ratio was close to 30%.

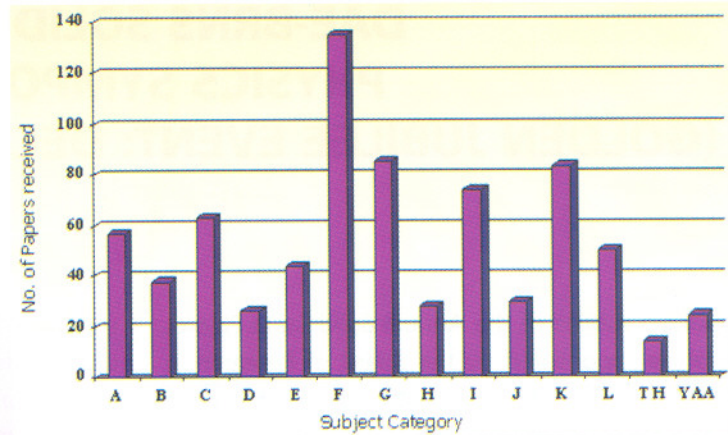

Fig. 1: Distribution of contributed papers (by subject category)

A bar-chart of the subject category-wise distribution of the contributed papers is shown in Fig.1. Fig.2 shows the distribution of contributed papers from different institutions. Clearly, universities and non-DAE research institutions contributed a major percentage to the total number of papers.

The Symposium was inaugurated by Dr P.K. Iyengar, Former Chairman, AEC, who also kindly consented to give the inaugural address. Dr S. Banerjee, Director, BARC, presided over the inaugural function and Dr V.C. Sahni, President Indian Physics Association, Director RRCAT, Indore and Director, Physics Group, BARC gave the keynote address. Several senior scientists (now mostly retired), who had given their best to the growth of condensed matter research in the country were invited to attend the symposium as special invitees. In all, about 800 delegates and participants attended the inaugural session.

The symposium comprised of 19 sessions of invited talks covering different areas of condensed matter physics. These invited talks were

delivered by senior scientists both from within the country as well as from abroad. In all, 31 lectures were delivered. These included two special evening lectures by Dr R. Chidambaram, Principal Scientific Advisor to the Government of India and DAE Homi Bhabha Professor on "Physics, Development and Security" and by Dr V. C. Sahni, Director, RRCAT, Indore and Director, Physics Group on "Three Cheers to the INDUS-II

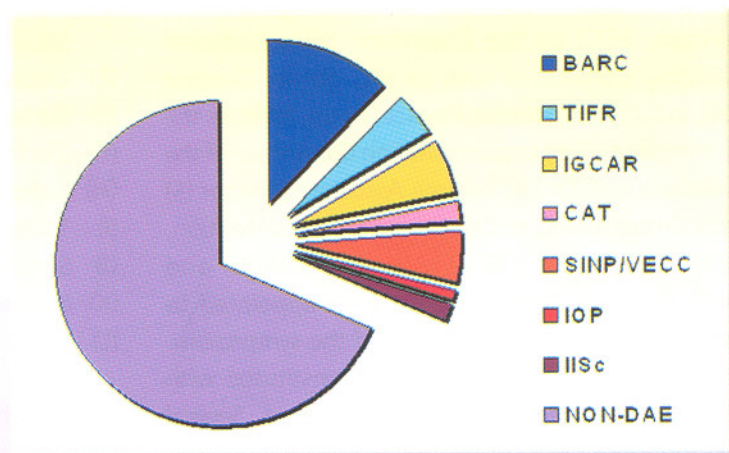

Fig. 2: Distribution of contributed papers (by institution)



Dr P.K. Iyengar, releasing the Proceedings of the symposium given to him by Dr V.C. Sahni, Director, Physics Group, BARC. To his left are Director, BARC and Dr J.V. Yakhmi, Convener, SSPS - 05.

to evaluate them for Awards. The *Golden Jubilee Young Achiever Awards* were given to Dr V. P. S. Awana, NPL, New Delhi, Dr K. Maiti, TIFR Mumbai, and Dr Ranjan Mittal, BARC, Mumbai. The award comprised of a Gold Medal and a Citation. The awardees were also asked to make oral presentations of their research work, whereas all other competing candidates presented their work as posters. Apart from this, awards were also given for Best Thesis Presentation to Ms Parinda Vasa (TIFR, Mumbai), Ms Pratibha Sharma (University of Rajasthan, Jaipur) and Best

Scientific Community – Using/Building Large facilities for Physics Experiments”.

Poster Presentations to Ms Mahashweta Nanda (IACS, Jadhavpur) and Mr Vikram Gadagkar (IISc, Bangalore).

A unique feature of this symposium was the institution of a “Golden Jubilee Young Achiever Award”, with an aim to foster creative, original scientific research in condensed matter physics in the country. Nominations were received through proper channel from young (below 40) researchers/scientists working in India and a special refereeing committee was appointed under the Chairmanship of Prof. S.S. Jha, Emeritus Professor, Indian Institute of Technology, Mumbai,



A group photo of the participants of SSPS - 2005 outside CC auditorium, BARC.

भा.प.अ. केंद्र के वैज्ञानिकों को सम्मान BARC SCIENTISTS HONOURED



एफडी, भापअ केंद्र के बी.के.शाह को NACE इंटरनेशनल (नेशनल एसोसियेशन ऑफ करोजन इंजीनियर्स), इंडिया सेक्शन द्वारा संक्षारण विज्ञान में उत्कृष्टता - 2005 हेतु पुरस्कृत किया गया। यह पुरस्कार तमिल नाडु के महामहिम राज्यपाल

द्वारा चन्नई में आयोजित CORCON-2005 सम्मेलन के दौरान प्रदान किया गया। श्री शाह को यह पुरस्कार (i) स्टेनलेस स्टील के स्थानीकृत संक्षारण, (ii) जर्कोनियम मिश्रधातुओं का आक्सीकरण एवं हाइड्राइडिंग एवं (iii) NDT द्वारा संक्षारण मानीटरन एवं विकास कार्य के सम्मानार्थ प्रदान किया।

B.K. Shah of AFD, BARC was given the Excellence in Corrosion Science -2005 award by NACE International (National Association of Corrosion Engineers), India Section. This Award was presented by Hon. Governor of Tamil Nadu during the Conference CORCON-2005 at Chennai. Mr Shah received this award in recognition of his R&D work related to (i) Localized Corrosion of Stainless Steels, (ii) Oxidation and Hydriding of Zirconium Alloys and (iii) Corrosion Monitoring by NDT."



सायनिकी प्रभाग, भापअ केंद्र के डॉ. एस.आर. भारद्वाज को दिनांक 6-10 फरवरी 2006 के दौरान राजस्थान विश्वविद्यालय, जयपुर में आयोजित पंद्रहवीं राष्ट्रीय संगोष्ठी एवं तापीय विश्लेषण पर कार्यशाला (THERMANS 2006) में

नाभिकीय एवं अन्य तकनीकी पदार्थों के उच्च तापमान रसायनिकी के क्षेत्र में उनके उत्कृष्ट योगदान के लिए भारतीय तापीय विश्लेषण संस्था द्वारा NETZSIH -ITAS पुरस्कार 2006 प्रदान किया गया।

Dr S.R. Bharadwaj of Chemistry Division, BARC received the NETZSCH-ITAS AWARD 2006 by the Indian Thermal Analysis Society for her outstanding contributions in the field of high temperature chemistry of nuclear and other high tech materials, at the Fifteenth National Symposium and Workshop on Thermal Analysis (THERMANS 2006) which was held at University of Rajasthan, Jaipur during 6-10 February 2006. The prize was given by the Indian Society for Mass Spectrometry, Mumbai.



संदीप डी. मेंद, एसआरएफ (डीएफएस), एमएचए, एनए यूनिट, विश्लेषणात्मक रासायनिकी प्रभाग, भापअ केंद्र को दिनांक 28 जनवरी से 1 फरवरी 2006 के दौरान मन्नार, केरल में आयोजित ट्रि.एनियल इंटरनेशनल सिम्पोजियम ऑन मास

स्पेक्ट्रोमेट्री (आईएसएमएस) के आइसोटोप संयोजन एवं सांद्रण मापन (आईसीसी) सत्र में पोस्टर प्रस्तुतीकरण हेतु प्रथम स्थान प्राप्त हुआ। पोस्टर आईसीपी-एमएस डिटेक्शन आफ रेयर-अर्थ टैंग्ट्स इन प्रिंटेड लेटर्स आफ्टर आफसेट प्रिंटिंग - एन एंड टू फोरेन्सिक/ डाक्युमेंट एजामिनेशन के लेखक एस.डी. मेंद, एन. चट्टोपाध्याय, एस-ए कुमार, ए.के. बासु, सीएच. गांधी एवं एम. सुदर्शनन हैं। पुरस्कार में योग्यता प्रमाणपत्र एवं नकद पुरस्कार था जो इंडियन सोसाइटी आफ मास स्पेक्ट्रोमेट्री द्वारा प्रदान किया गया।

Mr. Sandip D. Maind, SRF (DFS), MHA at NAA Unit, ACD, BARC was awarded the First Prize for the poster presentation in the Isotope Composition and Concentration Measurements (ICC) session at the Triennial International Symposium on Mass Spectrometry (ISMAS) held during January 28 – February 1, 2006 at Munnar, Kerala. The paper was entitled "ICP-MS detection of rare-earth taggants" The award carried a certificate of merit and cash prize which was given by the Indian Society for Mass Spectrometry, Mumbai.

Exhibition on Pressure Vessels and Piping (OPE-2006), held at Chennai during February 07-09, 2006. The conference was organised by Indian Institute of Metals, India, Institute of Materials, Engineering, Australia, Welding Technology Institute, Australia, Bharat Heavy Electricals Limited, Tiruchirapalli, Larsen & Toubro, Mumbai and Indira Gandhi Centre for Atomic Research, Kalpakkam.



B.B. RUPANI

बी.बी. रुपानी, के. मधुसूदनन एवं कुंदन कुमार भारतीय दारिद्र्य भारी पानी रिएक्टरों में शीतलक वाहकों की सेवा आयु के मूल्यांकन एवं बढ़ोतरी हेतु सुदूर प्रचालनीय अभिनव उपकरण एवं प्रौद्योगिकियों के विकास पर कार्य कर रहे हैं। इंटीग्रेटेड गार्टर स्प्रिंगरिपोज़िशनिंग सिस्टम, सिल्वर स्क्रैप सैंपलिंग तकनीक, बोट सैंपलिंग तकनीक, इन-सिट्टु प्रापर्टी मेजरमेंट सिस्टम, हाइड्रोजन समतुल्य मूल्यांकन उपकरण जैसी प्रौद्योगिकियां विकसित की गईं एवं इनमें से कुछ प्रौद्योगिकियों का विभिन्न रिएक्टर स्थलों में प्रयोग किया गया है।



K. MADHUSOODANAN



KUNDAN KUMAR

B . B . R u p a n i ,
K. Madhusoodanan and
Mr Kundan Kumar of RED,
BARC received the best
poster award for
the paper presented
in the International
Conference and



सुवेन्दु मंडल, आनन्द बाडीगन्नावर, डी.एम.काले एवं जी.एस.एस. मूर्ति, नाभिकीय कृषि एवं जैव प्रौद्योगिकी प्रभाग, भाभा परमाणु अनुसंधान केंद्र ने मार्च 1-3, 2006 के दौरान तामिलनाडू एग्रिकल्चर यूनिवर्सिटी, कोयम्बटूर में आयोजित द्वितीय राष्ट्रीय प्लांट प्रजाति

सम्मेलन प्लांट ब्रीडिंग इन पोस्ट जेनेटिकएरा, 2006 में इंटक्शन आफ जेनेटिक वेरियेबिलिटी इन ए टिजीज रेजिस्टंट ग्राउंडनट ब्रीडिंग लाइन, नामक शोध पत्र के लिए श्रेष्ठ पोस्टर पुरस्कार प्राप्त किया।

A research paper titled "Induction of genetic variability in a disease resistant groundnut breeding line", authored by Suvendu Mondal, Anand Badigannavar, D.M. Kale and G.S.S. Murty of Nuclear Agriculture and Biotechnology Division, BARC, has won the best Poster Award in the second National Plant Breeding Congress 'Plant Breeding era', 2006 held at Tamilnadu Agriculture University, during March 1-3-2006.

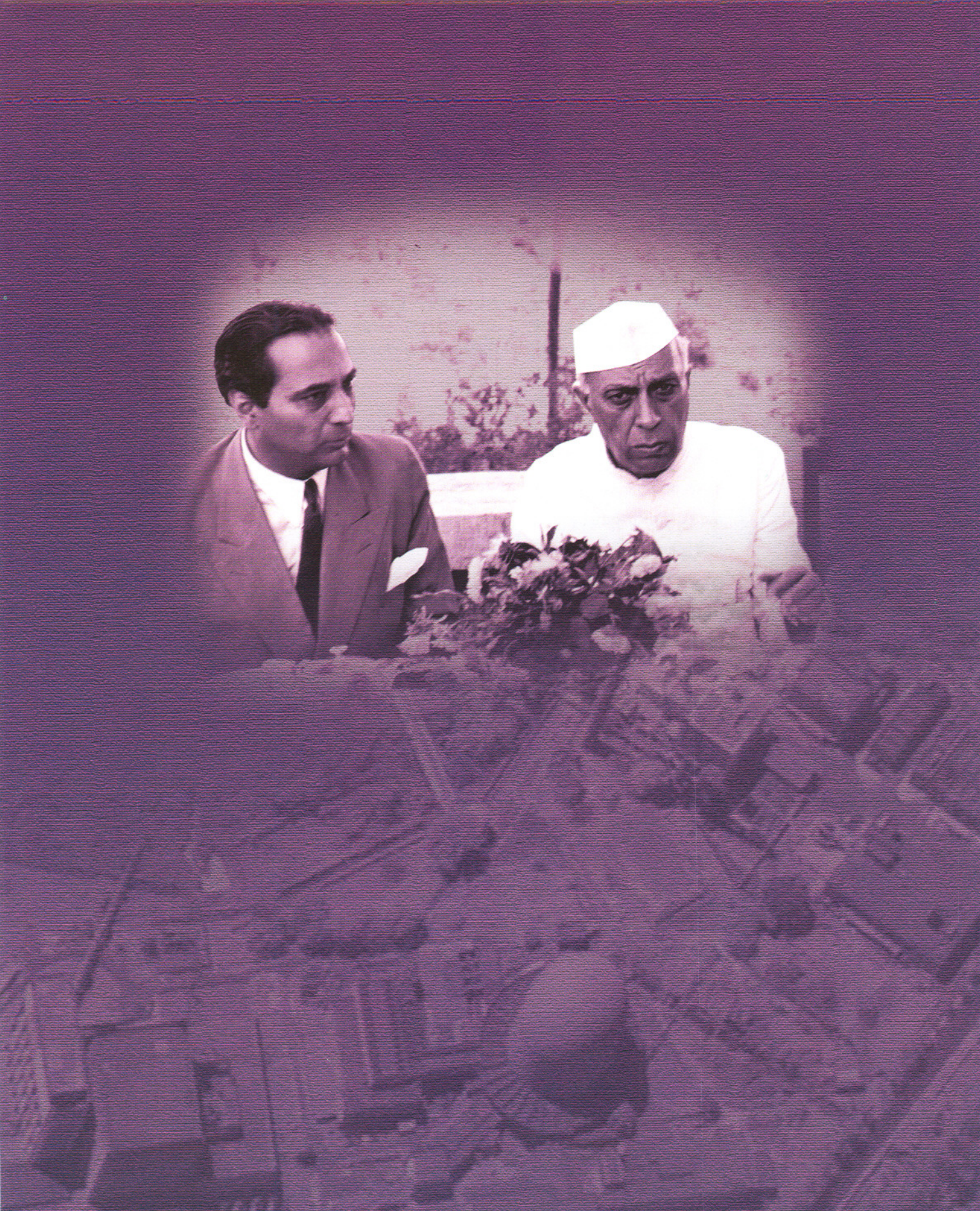

Edited & Published by: Dr. Vijai Kumar, Head, Scientific Information Resource Division,
Bhabha Atomic Research Centre, Trombay, Mumbai 400 085, India.

Editorial Management : Ms. S.C. Deokattey, Computer Graphics & Layout : P.A.S. Warriar, SIRD, BARC

BARC Newsletter is also available at URL: <http://www.barc.gov.in> (for private circulation only)