

# BARC

## NEWSLETTER

No. 198,  
July  
2000

### RADIOTRACER EXPERIMENT NEAR SAGAR DUMPING BUOY IN THE HUGLI ESTUARY

A. S. Pendharkar, Noble Jacob, V. N. Yelgaonkar and S. V. Navada  
Isotope Applications Division

#### Introduction

Studies on sediment transport and accumulation are of vital importance to many projects. These may include river and marine engineering problems such as dock construction, coastal reclamation schemes, irrigation project etc. which involve direct interference with the water to land or bed boundary, or environmental projects. Bedload transport studies in ports and harbours are of economic significance for dredging activities. The studies help in selecting right alignments for new navigational channels and often in the study of suitability of sites selected for disposing off dredged sediment. The maintenance of the optimum depth for smooth sailing of vessels demands continuous dredging in channels throughout the year.

The shipping channels leading from the deep sea of Bay of Bengal to the dock system at Haldia in the Hugli estuary encounters a number of shallow patches. To maintain the required depth for smooth sailing of vessels continuous dredging throughout the year is carried out. The dredged material is dumped at suitable

#### Contents

1. Radiotracer experiment near Sagar dumping buoy in the Hugli estuary ..... 1
2. Design and development of ZnS (Ag) scintillator based detector for monitoring Pu-in-air .... 9
3. Director, BARC, attends farmers' meet at Tarapur ..... 12
4. 42<sup>nd</sup> solid state physics symposium ..... 14
5. Forthcoming symposia ..... 15
6. BARC scientist honoured ..... 16

locations. The locations are selected in such a way that the turn around time of dredger is kept to a minimum.

For dredging over other areas in the estuary, viz. Middleton, Auckland and Jellingham shoals, dumping grounds have already been selected by conducting different investigative studies including radioisotope tracer studies in earlier years.



Plate 1 Injection apparatus

Depth in the shipping channel through the Hugli estuary leading to the dock systems at Haldia and Calcutta is maintained by dredging and is carried out extensively round the year. Dumping and disposal of huge quantities of dredged materials to the tune

of around 15 to 20 million m<sup>3</sup> per annum has become a problem. The previous practice of dumping the material in deep pockets inside the estuary could no longer be continued due to shoaling of all such pockets. Presently the dumping is done at sea-face to allow the dumped material to be taken into the deep bay. Since such dumping is done during flood tide as well as ebb tide, some apprehension regarding dredged material returning back to the estuary during flood tide was felt. At the request of Calcutta Port Trust (CPT), a tracer study using Scandium-46 as radiotracer was carried out during the period November 1998 to February 1999, to examine the possibility of the return of the disposed dredged materials from the dumping site to regions inside the estuary during flood tide.

Movement due to ebb currents was not of much interest as the ebb currents would take material into the bay which would not pose any problem in the shipping channel. The material was injected during low water to essentially find out its movement by flood tide. It was ensured that no dumping takes place on the upstream side of the injection point to avoid the radiotracer material being buried under the dredged spoil.

The injection point for the radioactive tracer was just at the sea face at about 145 km from Calcutta. It is also about 35 km downstream of the Haldia Township and is nearly 10 km from Sagar Island. The other bank of the Hugli Estuary, i.e. western bank, is more than 20 km away from the injection point. There is a village in Sagar Island about 15 km away from the injection point and its population is about 0.2 million. CPT ensured that no fishing activities around the injection point were carried out in the study area during the injection period and also the post injection-monitoring period.

## Background Survey

Since the radiotracer study is carried out extensively from 1984 onwards in the Hugli Estuary, background data is well known in the area, which is 2000-2500 cpm. This was also ensured during the present study and was found to be of the same order. Waterproof scintillation detector mounted on an iron sled, connected to a scaler/ratemeter was dragged on the seabed and was used for background survey as well as for post injection tracking. The position of the detector at any time was fixed by a computerised positioning system available on board.

## Selection of Grain Size

The radiotracer should have identical physico-chemical properties and hydrodynamic behaviour as of natural sediment. The radiotracer  $^{46}\text{Sc}$  in the form of 1% scandium glass, having specific gravity and particle size distribution similar to that of natural sediment in the range of 45-150  $\mu\text{m}$ , was prepared. Hydraulic Study Department of Calcutta Port Trust supplied the data regarding the size distribution of materials.

## Tracer Injection

Since the experiment was aimed to study the movement of the dumped dredged-spoil mainly during flood tide, the injection was carried out at 1550 hrs on board R. V. Anusandhani during low water time of 17<sup>th</sup> November 1998 with the Sagar range of tide 3.72 m.

Prior to the injection, a dummy trial on the morning of 17<sup>th</sup> November 1998 was carried out on board R. V. Anusandhani.



Fig. 1 Location map of the study areas



Plate 2 Mixing of  $^{46}\text{Sc}$  tracer in the injection apparatus

Radiotracer (370 GBq about 10Ci of Scandium-46), in the form of Scandium glass powdered to the particle size distribution of the silt (confirmed by CPT), was mixed with 5 kg. of sand from the site

inside the injection apparatus. The injection was carried out at position  $21^{\circ} 37' 55''$  N and  $88^{\circ} 00' 44''$  E at a depth of about 9.2 m (Fig.1). The injection apparatus used for releasing the radiotracer was disposed off by dumping it at a place about 5 km away from the injection site.

## Post Injection Tracking

Four post injection trackings were carried out. The schedule of the trackings was as below:

|                          |                      |
|--------------------------|----------------------|
| 1 <sup>st</sup> Tracking | November 18, 1998    |
| 2 <sup>nd</sup> Tracking | December 1-2, 1998   |
| 3 <sup>rd</sup> Tracking | December 21-23, 1998 |
| 4 <sup>th</sup> Tracking | February 2-3, 1999.  |



Plate 3 Detector with sledge for tracking the activity

### 1<sup>st</sup> Tracking

Tracking started from the injection point and continued around 50m distance from the injection point. Initially almost for about 2 hours, there was no trace of the radiotracer patch anywhere near the vicinity of injection point. Later on tracking continued at a distance of 100 to 150m from the injection point. High count rate of the order of 400,000 cpm was observed. Tracking continued further towards the south, i.e., towards the sea as the injection was done during ebb tide and it was expected that the movement should be towards south only. Area

covered during the first tracking was about 4 km in length and 500 m wide. Transport diagram of 1<sup>st</sup> tracking is shown in Fig. 2.



Plate 4 Tracer monitoring in progress

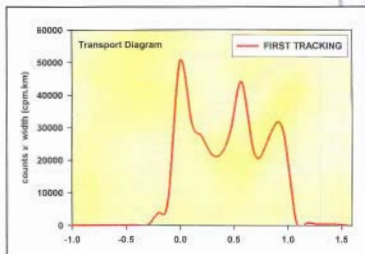

Fig. 2 Transport diagram of 1<sup>st</sup> tracking

### 2<sup>nd</sup> Tracking

Tracking continued in the vicinity of the injection point and high count-rate of the order of 20,000 cpm was observed at about 500m south of the injection point. The area covered during this tracking was about 4 km in length and 500m wide. Transport diagram of 2<sup>nd</sup> tracking is shown in Fig. 3.

### 3<sup>rd</sup> Tracking

Radioactivity was detected at about 1.5 km south of injection point. Highest count-rate observed was in the range of 15,000 cpm. High counts of about

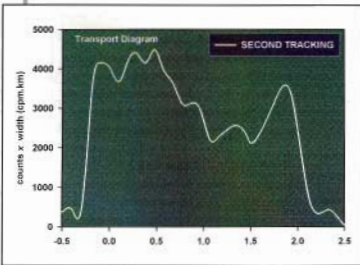

Fig. 3 Transport diagram of 2<sup>nd</sup> tracking

500 cpm were also observed at 2 locations towards north of injection point about 2.5 km distance. Total distance covered during this tracking was about 5.5 km in length and 700m wide. Transport diagram of 3<sup>rd</sup> tracking is shown in Fig. 4.

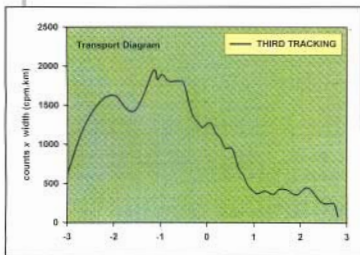

Fig. 4 Transport diagram of 3<sup>rd</sup> tracking

#### 4<sup>th</sup> Tracking

The fourth tracking was carried out after a gap of about 1 month from the previous tracking. Area covered during this tracking was about 6 km in length right from north to south of injection point and almost about 800m wide. Background counts were noticed at all places, which confirmed that the activity had been completely dispersed.

## Observations

During the first tracking, the movement observed was very fast, at the rate of 430m per day, an unusual occurrence. Comparatively, high counts were observed almost upto 2 km length towards sea, i.e., towards the south of injection point but in the shipping channels. However, towards north of injection point, activity spread observed was only about 300 m. The total activity recovered during the first tracking was 80%. Multiple peaks are observed in the transport diagram.

In the second tracking, predominant movement was towards south of injection point and a small patch (only one or two isolated points) was observed towards north of injection point. Total width of the spread was appreciably wide as against the first tracking but highest counts observed were only of the order of 20,000 cpm. Velocity that was observed during the second tracking was 27m per day. Activity recovered was only 19%.

In the third tracking, total spread observed was almost 6.5 km in length of which about 3 km was towards the south of injection point and about 3.5 km was towards the north where at a few isolated points, some patches were detected. Highest count rate observed was only 15,000 cpm. Width of the patch was again narrow as compared to second tracking. Total activity recovered was only 14% out of which 3% was north of injection point and the remaining was south of injection point. No tracer patch was observed in the shipping channels.

Area covered during the fourth tracking was almost 6 km in total length, covering about 4 km towards south of injection point and 2 km towards north of injection point, with a width of more than 800m. Only background counts were observed during this tracking. Combined transport diagram is shown

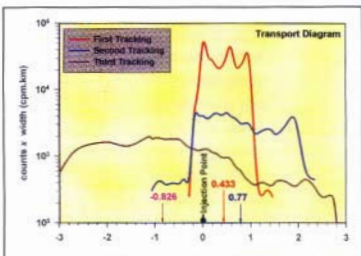

Fig. 5 Composite transport diagram of the three trackings

In Fig. 5. Isocount contour map prepared using the data obtained from three post injection trackings for the experiment is shown in Fig. 6.

From the trackings carried out during the period from November 18, 1998 to February 3, 1999, it was observed that the bed movement was predominantly towards the sea. Though the radiotracer injection was carried out during low water, the material was found to have moved downstream, i.e., towards the sea, with ~ 2-3% of the material moving upstream.

This confirms the fact that the selection of the dumping ground made by the Hydraulic Study Department on the basis of hydrological observations carried out earlier was judicious. It was also observed that the flow pattern in this zone, where the Sagar dumping buoy is located and where the injection of the radiotracer was carried out, has a predominant current pattern towards the sea. More significant finding of the tracking was that no movement of the material had taken place towards Sagar anchorage area. It was also observed that the Auckland Bar which is towards north-western direction of the dumping ground, remained unaffected from the dumping activity, as no radiotracer material was found there. The most

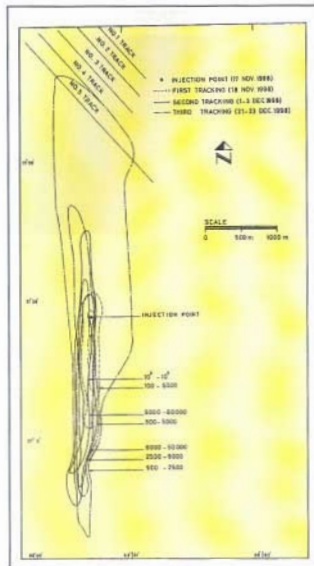

Fig. 6 Isocount contour map

striking fact from this experiment was that the material had moved in a direction, which is in between the Mizzen Sand Group on the west and the Upper Long Sand on the east. The movement of the radiotracer shows that the bed movement from the dumping ground has dominant southward movement through the passage bounded on the western side by the Mizzen Sand and by the Upper Long Sand on the eastern side.

CPT has also carried out simultaneous hydrographic survey of the dumping zone during the second tracking and at Sagar Anchorage area during the third tracking. The differential hydrographic charts of

these two areas clearly confirm the findings of the radiotracer study conducted during the period.

During the 3<sup>rd</sup> and 4<sup>th</sup> trackings, comparatively small percentage of material was detected over an area of about 5-6 km long in the north-south direction and 700-800 m wide in the east-west direction from the injection point. This may be due to dumping of huge quantities of dredged materials. It would have been ideal had there been no dumping and disposal of dredged material in the whole area covering an area of about 5 km radius. However, a situation of this type was impracticable. Considering the fact that the dredging of estuary, especially at Jellingham and Auckland, is being carried out continuously round the clock and over many years, a situation with no dumping is a hypothetical case.

### Analysis of the Data

It was observed that the maximum longitudinal spread of radioactivity during the study was about 7000 m and the maximum transverse spread was about 800 m. The combined isocount contours obtained during the three post injection trackings are shown in Fig. 6. The cumulative counts multiplied by lateral distance of spread (cpm x m) perpendicular to the general axis of transport at intervals of 50 m along the general transport axis are plotted for each tracking. These diagrams are called transport diagrams and each is characterised by its centre of gravity. Centre of gravity is determined by the following formula:

$$\bar{X} = \frac{\int C \otimes X dx}{\int C dx} \quad (1)$$

The transport diagram with centre of gravity of each tracking is shown in Fig. 5. From the shifts in centre of gravity of consecutive trackings, the mean

velocity of transport is calculated and is given in Table 1.

### Determination of the Transport Thickness

The area under each transport diagram (cpm x m<sup>2</sup>) gives an estimate of activity accounted for during each tracking (Table-1). It was observed that in none of the three trackings, the total injected activity of 370 GBq (10Ci) was recovered. As bed-load moves, the tracer gets mixed within the thickness of moving bed. This depth of tracer burial is called "Transport-thickness" and is the mean distance between the surface of the bed and the most deeply buried radioactive particles. The determination of transport thickness is based on the count rate balance. The total integrated count rate N (cpm x m<sup>2</sup>) observed during the tracking is related to the transport thickness by the following relation:

$$N = \frac{\beta KA}{\alpha E} (1 - e^{-\alpha E}) \quad (2)$$

where:

- N =  $\iint n.ds$ , the count rate integrated over the whole surface area of tracer patch,
- K = calibration factor of the detector used. In this case, it is 4260 cpm/ $\mu$ Ci/m<sup>2</sup>,
- A = total activity injected, 370 GBq (10Ci),
- $\alpha$  = attenuation coefficient characteristic of the isotope, bed material and geometry of detector which is 0.15/cm for Scandium-46,
- E = transport thickness (cm),
- $\beta$  = a function of transport thickness and shape of distribution of tracer concentration with depth. The value of  $\beta$  is taken as unity, assuming that the distribution of tracer within the moving bed is uniform.

**Table 1**

| Tracking No. | Days after injection | Location of cg (km) | Activity spread N <sup>o</sup> (cpm.m <sup>2</sup> ) | V <sub>m</sub> (m/d) | E (cm) | Q (t/d/m) | % recovered |
|--------------|----------------------|---------------------|--|----------------------|--------|-----------|-------------|
| 1            | 1                    | 0.433               | 34256 X 10 <sup>6</sup>                              | 433                  | 2.6    | 16.88     | 80          |
| 2            | 13                   | 0.770               | 8025 X 10 <sup>6</sup>                               | 27                   | 10.8   | 4.38      | 19          |
| 3            | 34                   | 0.825               | 6109 X 10 <sup>6</sup>                               | 74                   | 11.4   | 12.73     | 14          |

Table 1 gives the value of E calculated from eq. (2). The bed load transport rate Q (tonnes/day) can be expressed as:

$$Q = \rho \cdot L V_m E \quad (3)$$

where:

- $\rho$  = sediment bulk density (1.5 tonnes/m<sup>3</sup>)
- L = width of transport (m)
- V<sub>m</sub> = mean velocity of transport (m/d)
- E = transport thickness (m)

Table 1 also gives bedload transport rate per metre width.

From Table1, it is seen that in the 1<sup>st</sup> tracking, a recovery of 80% of the injected activity was possible. However, in the 2<sup>nd</sup> and 3<sup>rd</sup> trackings, recovery was very less. This is probably due to the continuous dumping going on in the Sagar Dumping Buoy area and the high current in this locality.

## Discussion

The radiotracer was injected during low water near Sagar Dumping Buoy to investigate the movement of the bed material in flood tide. From hydraulic point of view, the expected bed movement in flood tide should be predominantly in the landward direction, i.e., towards the north of Sagar Dumping Buoy. However from the hydraulic observation data of the

earlier years, the bed velocity vectors were seen to be showing the movement of material southwards. The present study confirms the movement of the bed material in the southward direction, i.e., seawards, specifically within a narrow zone bounded on the western side by the Mizen Sand and eastern side by the Upper Long Sand (Fig.1).

## Conclusion

- The bed material movement was predominantly towards south, i.e., towards Bay of Bengal.
- No material was found in the shipping channels as well as in Sagar Anchorage area.
- Three months after the injection, i.e., during third tracking, a very small part of the movement was seen towards north of the injection point. However, this is only 2% to 3% of the total activity measured.
- During 2<sup>nd</sup> and 3<sup>rd</sup> trackings, recovery was only about 19% and 15% due to movement of material into deep sea.
- It is observed that the decision to select the dumping ground at Sagar Dumping Buoy was found to be technically in order.
- It is suggested to carry out one more radiotracer experiment in this location to observe the movement of the dredged material for locating another dumping place



# DESIGN AND DEVELOPMENT OF ZnS (Ag) SCINTILLATOR BASED DETECTOR FOR MONITORING Pu-IN-AIR

K.Dubey, G.J.M.Coelho, S.Y.Phadtare, R.D.Changrani, P.K.Dey and D.D.Bajpai  
PREFRE, Fuel Reprocessing Division, Nuclear Recycle Group

## Introduction

In a spent fuel reprocessing plant and also in a plutonium fuel fabrication facility, prompt and timely detection of air-borne plutonium is not only an essential requirement for minimizing inhalation hazard, but also an aid in the investigation of the source causing it. Presence of short lived daughter products of Radon( $^{222}\text{Rn}$ ) and Thoron( $^{220}\text{Th}$ ) in air interferes with the prompt detection of air-borne plutonium.



Fig. 1 ZnS(Ag) scintillator detector based Pu-in-Air monitor

Presently installed continuous air monitors mostly use a semiconductor detector to discriminate between 5.15 MeV particle energy of  $^{239}\text{Pu}$ , and 6 MeV, 7.8 MeV and 8.7 MeV particle energies of daughter products of radon and thoron. These detectors have given satisfactory performance in amenable environmental conditions like those prevalent in air conditioned laboratories handling plutonium in globe boxes. However, in certain areas of a reprocessing plant, having hostile

environmental conditions with temperature and humidity above normal values and at times nitric acid vapors in trace quantity, the performance of the semiconductor detector, due to its very nature, is found to get deteriorated within a few months after installation. Therefore, other methods of detection of air-borne plutonium were considered which could be used to make air monitors more rugged and economical than the ones using the semiconductor detector. It was found that the use of aluminized mylar films of predetermined thickness as absorbers could be used to distinguish between particles from plutonium and those from daughters of radon and thoron. Based on this, a Pu-in-Air monitor that directly displays count rate due to plutonium has been designed, fabricated and installed in PREFRE plant, Tarapur, and is in use (Fig. 1 & Fig. 2).

## Design Criteria and Basic Principle

Based on studies, an air monitor using ZnS(Ag) scintillation detector was fabricated. In this monitor, two sets of readings are taken, one for detecting particles from plutonium and radon-thoron daughter products after covering the detector with a single layer of aluminized mylar film absorber of thickness  $0.25 \text{ mg/cm}^2$ , and the other after covering the detector with a mylar absorber of thickness  $1 \text{ mg/cm}^2$  to cut off particles from plutonium. Based on experiments, it was also observed that the mylar film of thickness  $1 \text{ mg/cm}^2$  not only cuts off the  $\alpha$  particles of  $^{239}\text{Pu}$  completely, but also 65%

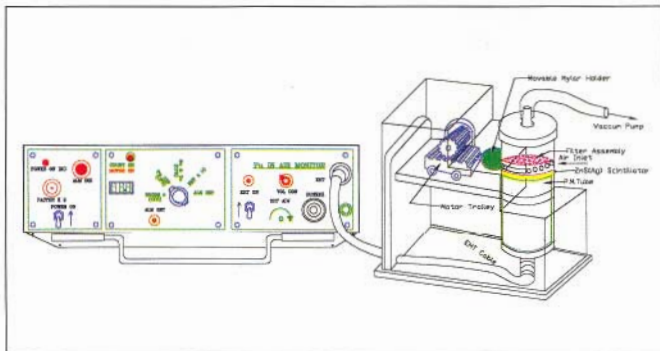

Fig. 2 Zn(Ag) scintillation based continuous Pu-in-Air monitor

of the particles contributed by the daughters of radon and thoron. Air sample is collected on a glass-fibre filter paper loaded in the filter holder. The pulses from the detector are integrated for 33 seconds and the readings are taken. The difference between the two readings is used to estimate air-borne activity due to plutonium.

Let  $X_1$  = Air activity count rate due to  $\alpha$ - particles contributed by  $^{239}\text{Pu}$  and daughter products of radon and thoron combined together, using single layer of aluminized mylar film of thickness  $0.25 \text{ mg/cm}^2$ .

&  $X_2$  = Air activity count rate due to 35% of  $\alpha$ - particles contributed by the daughter products of radon and thoron alone using aluminized mylar film of thickness  $1.00 \text{ mg/cm}^2$ .

Hence,  $X_1 - \mu X_2$  = Air activity count by  $^{239}\text{Pu}$  alone, where ' $\mu$ ' is an experimentally determined factor.

## Experimental Observations

A ZnS(Ag) scintillation detector with its scintillator covered with aluminized mylar film of thickness  $0.25 \text{ mg/cm}^2$  and connected to an alpha counting system was exposed to a source of  $\text{Pu}^{239}$  and the reading was taken. By keeping aluminized mylar sheets each of thickness  $0.25 \text{ mg/cm}^2$  above the source, the number of mylar sheets require to cut off particles from  $\text{Pu}^{239}$  was determined. It was found that 4 sheets of mylar films amounting to a thickness  $1.00 \text{ mg/cm}^2$  were sufficient to cut off  $\alpha$ -particles completely from  $\text{Pu}^{239}$  source.

## Determination of $\mu$

In order to determine the value of  $\mu$ , the detector was installed in an area having air borne activity only due to daughters of radon and thoron with negligible air borne activity due to plutonium. Two sets of readings, one with the scintillator covered with one sheet of mylar film of thickness  $0.25$

mg/cm<sup>2</sup>, indicating total  $\alpha$ -activity due to radon-thoron daughter products(A), and the other with the scintillator covered with 4 sheets of mylar film of effective thickness of 1.00 mg/cm<sup>2</sup>, indicating 35% of total  $\alpha$ -activity(B), were recorded. The detector with an efficiency of 25% was connected to an air sampling system consisting of a vacuum pump and an air rotameter to maintain the air flow rate of 50 lpm through the filter paper and the count rates were monitored and recorded at the end of every five hours and the ratio A/B was calculated as shown in Table 1.

**Table 1 : Determination of  $\mu$**

| SNo. | Count Rate(A) | Count Rate(B) | $\mu=A/B$ |
|------|---------------|---------------|-----------|
| 1.   | 200           | 70            | 2.85      |
| 2.   | 400           | 150           | 2.66      |
| 3.   | 650           | 220           | 2.95      |
| 4.   | 900           | 320           | 2.81      |
| 5.   | 1200          | 400           | 3.00      |
| 6.   | 1600          | 575           | 2.78      |
| 7.   | 1750          | 620           | 2.82      |
| 8.   | 1900          | 680           | 2.79      |
| 9.   | 2100          | 750           | 2.80      |
| 10.  | 2250          | 800           | 2.81      |
| 11.  | 2300          | 820           | 2.80      |

From the above table, the average value of  $\mu$  was found to be 2.82.

### Performance Verification

The filter paper removed from the instrument was further used for delay counting, an alternate method hitherto used for estimation of air borne activity due to plutonium. In this method, the activity collected at the filter is counted after a delay of four days to ensure the decay of radon and thoron activity to negligible level. It was found that plutonium air

borne activity calculated from the formula  $X_1 - 2.82 X_2$  agreed fairly well with that estimated from Delay Counting Technique. A comparative study of the performance of the new detector and delay counting method is shown in Table 2.

**Table 2 : Comparative Study of New Instrument with Delay Counting Method**

| S.No | $X_1 - 2.82 X_2$ CPM<br>DAC-h of Pu | ((DAC-h of Pu)<br>(DAC-h of Pu) |
|------|-------------------------------------|---------------------------------|
| 1    | 200 ( 55.5 )                        | 180 ( 50 )                      |
| 2.   | 200 ( 55.5 )                        | 170 ( 47.2 )                    |
| 3.   | 50 ( 13.8 )                         | 56 ( 15.5 )                     |
| 4.   | 60 ( 16.6 )                         | 78 ( 21.6 )                     |
| 5.   | 80 ( 22.2 )                         | 65 ( 18.0 )                     |
| 6.   | 60 ( 16.6 )                         | 42 ( 11.6 )                     |
| 7.   | 60 ( 16.6 )                         | 81 ( 22.5 )                     |
| 8.   | 200 ( 55.5 )                        | 172 ( 47.7 )                    |
| 9.   | 150 ( 41.6 )                        | 170 ( 47.2 )                    |
| 10.  | 900 ( 250 )                         | 850 ( 236.1 )                   |
| 11.  | 500 ( 138.8 )                       | 550 ( 152.7 )                   |
| 12.  | 500 ( 138.8 )                       | 500 ( 138.8 )                   |

### Electronic Circuit and Control

The newly designed and developed Pu-in-Air monitoring system consists of three main parts:

- ZnS(Ag) scintillation detector with single layer of aluminized mylar film of thickness 0.25 mg/cm<sup>2</sup> fitted in a SS 316 housing.
- A motorised assembly with a movable holder carrying an aluminized mylar film of thickness 1 mg/cm<sup>2</sup> and a control circuit for driving the geared motor assembly.
- Electronic circuit for calculating the mathematical function given by  $X_1 - \mu X_2$  as mentioned above and displaying the air activity due to <sup>239</sup>Pu only. The value of ' $\mu$ ' calculated experimentally is 2.8.

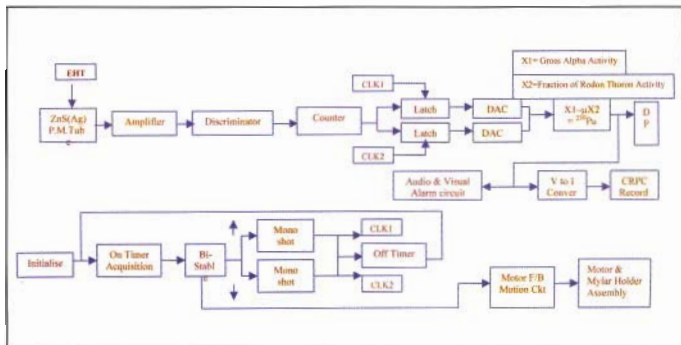

Fig. 3 Block diagram of the Pu-in-Air monitor

A block diagram of the system is depicted in Fig. 3.

### Cost Benefits and Import Substitution

The overall cost of the new indigenous Pu-in-Air monitor works out to be about Rs.40,000/- as against Rs.70,000/- for that of an imported semiconductor based Pu-in-Air monitor. Unlike a semiconductor detector, it is more rugged and less

prone to failure in adverse operating conditions prevalent in certain areas of the reprocessing plant. The instrument can detect 24 DAC-hr of air borne plutonium activity even when the activity of radon and thoron daughter products is 10 to 20 times the DAC of plutonium air activity. As it makes use of differential counts to arrive at Pu-in-Air activity, it is independent of varying background activity due to daughter products of radon and thoron.

## DIRECTOR, BARC, ATTENDS FARMERS' MEET AT TARAPUR

Dr Anil Kakodkar, Director, BARC, attended the farmers' gathering organised by Krishi Vigyan Kendra, Kosbad Hill (Gokhale Education Society) on the field of a progressive cultivator Mr Dhanesh Yashavant Save of Kudan, Tarapur, on May 7, 2000. Dr (Ms) A.M. Samuel, Director, Bio-Medical Group, BARC, Dr R.K. Mitra, Head, Nuclear Agriculture & Biotechnology Division (NA&BD), BARC, Dr A.K. Sharma, Food Technology Division,

and scientists from NA&BD attended the function. Dr Jayantrao Patil, former Member of Planning Commission, Government of India and Vice-President, Vasantrao Naik Krishi Prathisthan, presided over the function.

Dr Anil Kakodkar, Dr Jayantrao Patil, Mr P.M. Wagh, Station Director, Tarapur Atomic Power Station (TAPS), Mr A.K. Mishra, Project Manager, ROP,



*Dr Jayantrao Patil delivering his presidential address at the farmers' meet. Sitting on the dias, among others, are Dr Anil Kakodkar, Dr A.M. Samuel, Dr R.K. Mitra and Dr Mohan Bari*

Tarapur, and scientists from BARC visited the field demonstration plot of mungbean variety TARM-1 developed at BARC. The summer crop of mungbean was excellent and free from diseases and pests. Mr Dhanesh Save expressed his happiness and expected a harvest of around 12 to 15 q/ha. Director, BARC, appreciated the efforts of Dr Mohan Bari, Training Organiser, K.V.K. Kosbad Hill, for organising the demonstration and helping to establish the linkages between BARC and the farmers living in the vicinity of TAPS.

Nearly 300 farmers attended the meeting. Mr Dhanesh Save narrated his experiences and explained the advantages of cultivating mungbean variety TARM-1 as a summer crop and requested the farmers to visit the demonstration plot and the exhibition organised by BARC on this occasion. Dr Mohan Bari mentioned the role of Krishi Vigyan Kendra as an interphase between laboratory and the field. He also explained the need for closer synergy between BARC and the farmers of this region.

Dr S.E. Pawar, NA&BTD, BARC, who has developed the mungbean variety, TARM-1, reviewed the work carried out at BARC using radiation and radioisotopes in the field of agriculture.

Seeds of newly developed mungbean variety TU-96-2, groundnut variety TAG-24 and radiation induced mutant of green manuring crop *Sesbania rostrata* (popularly known as Dhaineha) were handed over to Dr Jayantrao Patil by Dr Anil Kakodkar for distribution and conducting trials on the cultivators' fields around Tarapur and adjoining villages.



*Examining the mungbean (TARM-1) crop on demonstration plot are (L to R) : Mr Save, Dr Mohan Bari, Dr Jayantrao Patil and Dr Anil Kakodkar*

Dr Anil Kakodkar, in his address, appreciated the concept of Dr Jayantrao Patil of developing seed co-operatives by farmers using BARC varieties for a sustainable system of seed multiplication and distribution and assured all possible help and technical inputs for this programme from BARC. He also reviewed the work on food irradiation and development of biopesticide at BARC for controlling insect pests. Dr Kakodkar suggested the setting up of an information kiosk at TAPS for BARC varieties and their cultural practices. He also suggested that BARC should develop a web site on agricultural research of Biomedical Group of BARC and a system of online information flow from BARC in response to questions posed by the farmers whenever they visit this web site at TAPS. Mr. Wagh enthusiastically agreed to the idea and

also suggested that BARC should arrange frequent Krishi melas for the farmers around Tarapur to familiarise them with the research activities of the Department of Atomic Energy.

Dr Jayantrao Patil, in his presidential address, thanked and appreciated the efforts of BARC scientists in developing high yielding mungbean varieties in particular and other crop varieties in general. He said that the farmers of the region are very innovative and capable of adopting newer crop varieties and production technology.

There was a lively question/answer session at the end of the meeting regarding various aspects of agricultural research at BARC.

---



## 42<sup>ND</sup> SOLID STATE PHYSICS SYMPOSIUM

The 42<sup>nd</sup> Solid State Physics Symposium, sponsored by the Board of Research in Nuclear Sciences (BRNS) of the Department of Atomic Energy, Government of India, was held at Indira Gandhi Centre for Atomic Research (IGCAR) during December 20-24, 1999.

A wide range of topics of current interest in solid state physics were discussed, which included phonon physics, phase transitions, superconductivity, magnetism, electronic structures, semiconductor physics, transport properties, surface science, liquid and glasses, novel materials, complex systems, instrumentation, etc. There were twenty-eight invited talks by experts in their respective fields from within the country and abroad and about 300 contributed papers were presented in the symposium. There were 14 theses presentations. The best thesis award this year went

to Dr Tamalika Bandyopadhyay, Department of Nuclear Physics, University of Madras, Madras, for her thesis entitled "Investigation of oxygen irradiated Pb doped and Pb-Sn doped Bi-2223 superconductors", and Dr V.K. Aswal, Solid State Physics Division, BARC, for his thesis entitled "Small-angle neutron scattering from micellar solutions".

A significant feature of the symposium was the tutorial session in "Low Temperature Techniques" for the benefit of young students. Experts from various laboratories in India who have developed various low temperature facilities conducted the sessions.

The symposium was inaugurated by Dr R. Chidambaram, Chairman, Atomic Energy Commission and Secretary, Department of Atomic Energy (DAE), Government of India. In his inaugural speech, he highlighted the tradition of this symposium and mentioned about the sanction imposed on India by the US and some western countries and how we were able to overcome the situation. Dr Placid Rodrigues, Director, IGCAR, gave a very scintillating and well thought presidential address. Dr Baldev Raj, Associate Director, Material Characterization Group, IGCAR, welcomed the participants and invitees to the symposium. Dr S.K. Sikka, Director, Solid State and Spectroscopy Group, BARC, in his introduction mentioned about the improved publication procedures adopted from last year and touched upon various aspects of the symposium.

A new feature of this year's symposium was the "News and Views Session". In this session, the opportunities at the three major national facilities - the Dhruva reactor at Trombay, the facilities available at different centres of Inter University Consortium for DAE facilities, and the recently

commissioned INDUS synchrotron source at Indore and Pelletron Accelerator at Nuclear Science Centre (NSC), Delhi, were described with an aim to boost the utilization of these facilities for condensed matter and material physics studies by researchers from all over the country.

To commemorate the birth centenary of Prof. K.S. Krishnan, a special evening lecture was organized on the topic, "Contributions of Prof. K.S. Krishnan to Condensed Matter Physics". Prof. R. Vijayaraghavan, an eminent solid state physicist, gave an account of his reminiscence and the important contributions made by Prof. K.S. Krishnan.



## FORTHCOMING SYMPOSIA

- A National Conference on "Quality Reliability and Management (NCQRM - 2000) will be held on September 7 & 8, 2000, Vellore, India. It is organised by the Department of Computer Science and Information Technology, Priyadarshini Engineering College, Vaniyambadi - 635 751, India, and sponsored by the Board of Research in Nuclear Sciences (BRNS). Academicians, scientists, executives and managers from educational, industrial and business organisations from around the nation are invited to participate in this Conference.

The Conference will cover the following topics : Management for Quality and Reliability, Quality Assurance and Inspection, Quality Assurance for Reliable Hardware and Software Systems, Tools and Methods for Quality Improvement in Process and Product, Reliability Issues in Networking, Reliability & Security of MIS, Database Management Systems, Software Reliability & Management, Failure Analysis as a Reliability & Maintainability

Analysis Tool, System Reliability Testing, and Reliability in Engineering Design.

(Contact : Dr Brijendra Singh, Secretary, Organising Committee, NCQRM-2000, Head, Dept. of Computer Science & Information Technology, Priyadarshini Engineering College, Vaniyambadi - 635 751, Vellore District (Tamil Nadu.), India; Phone : +91(4174)-25067, 25068, 25083 (Off.), +91(4174)-5998, 26646 (Res.); Fax : +91(4174)25067)

- The 6<sup>th</sup> International Asian Thermophysical Properties Conference (ATPC), organised by the Thermophysical Society of India (TPSI) under the auspices of Gauhati University, Assam, India, will be held during October 8-11, 2001 at the Department of Physics, Gauhati University, Guwahati-781 014, Assam, India. The Conference is sponsored by the Board of Research in Nuclear Studies (BRNS).

The Conference is concerned with theoretical, experimental and applied fields of the thermophysical properties of solids and fluids. Topics covered will include : Thermodynamical Properties, Transport Properties, Interfacial Properties, Optical and Thermal Radiative Properties and Data Correlation. Specific topics included in the Conference are Properties of Complex Fluids, Properties of Alternative Refrigerants, Properties of Process Design, Properties of Supercritical Fluids, Properties of New Composites, Thin Films, Polymers, Computer Simulations, Database Demonstrations, Properties of Molten Materials and Materials in the form of Solids & Fluids.

(Contact : Prof. M.N. Bora, Dept. of Physics, Gauhati University, Guwahati-781 014, Assam, India; Phone : +91(361) 570531 (Off.), +91(361) 450086 (Res.); Fax : +91(361) 570133; E-mail : kkhlg@gw1.dot.net.in)

• A Symposium on "Urolithiasis" & 10<sup>th</sup> Meeting of Urolithiasis Society of India (USOI) will be held from October 31 to November 2, 2000, at Chandigarh, India. It is sponsored by Department of Biochemistry, Panjab University, Chandigarh, Department of Urology, PGIMER, Chandigarh and Chandigarh Chapter of USOI and the Board of Research in Nuclear Sciences (BRNS). The deliberations during the symposium shall cover both Basic and Clinical aspects of the Urolithiasis problem. There will be Invited Lectures, Oral Presentations and Poster Sessions to cover the following topics : Epidemiology, Role of Nutrition, Inhibitors, Promoters and Matrix in Calculosis, Stone Analysis, Model Systems to study Nucleation, Growth and Dissolution of Crystals, Clinical and Surgical (ESWL, PCNL, URS) management of Urinary Stones, and Alternative Systems of Medicines.

(Contact : Prof. R.K. Jethi, Organising Secretary, Department of Biochemistry, Panjab University, Chandigarh - 160 014, India; Phone : +91(172) 534131, 534135 (Off.), +91(172) 716440(Res.); Fax : +91(172) 541409; E-mail : rkj@panjabuniv.chd.nic.in)

• A National Conference on "Science & Technology of Nano Materials and Clusters" (NCSTNC 2000) will be held during November 23-25, 2000 at Institute of Physics & Electronics, Barkatullah University, Bhopal-462 026, India.

The Conference is sponsored by University Grants Commission, Department of Science & Technology, New Delhi, and the Board of Research in Nuclear Sciences (BRNS).

Broad areas that are expected to be covered include: Nanomaterials Fabrication Techniques, Characterisation of Nanomaterials, Nanomaterials Properties (Mechanical, Electronic, Optical, Optoelectronic, Magnetic, etc.) and Applications, Multilayers, Quantum Dots and Quantum Wires, Related Fields (Nanolithography, Nanodevices, etc.) and Theoretical Developments in Nanomaterials Science.

The technical sessions during the Conference will be divided into review talks by eminent experts, and oral as well as poster presentations by researchers.

(Contact : Prof. R.K. Pandey, Chairman, NCSTNC-2000, Director, Institute of Physics & Electronics, Barkatullah University, Bhopal-462 026, India; Phone : +91(755)584066 (Off.), +91(755)721607 (Res.); Fax : +91(755)581227; E-mail: unihop@mp.nic.in)



## BARC SCIENTIST HONOURED

Dr Anubha Sharma of Bio-Organic Division, BARC,



has been selected by the Indian Chemical Society for the Dr D.S. Bhakuni Award for her paper, "Enzymatic Diastereo-selective Transformations - Some Case Studies", presented in the International Conference on Chemistry, held at Calcutta during December 11-16, 1999. The award carries a cash prize and a citation.

*Edited and published by Dr Vijai Kumar, Head, Library & Information Services Division, Bhabha Atomic Research Centre, Trombay, Mumbai 400 085.*

*Editorial Management : T.C. Balan; Computer graphics & layout : P.A.S. Warriyar.*

*BARC Newsletter is also available at URL:<http://www.barc.ernet.in>*

*(for private circulation only)*